

20-W MONO CLASS-D AUDIO POWER AMPLIFIER

Check for Samples: [TPA3001D1](#)

FEATURES

- **20 W Into 8-Ω Load From 18-V Supply (10% THD+N)**
- **Short-Circuit Protection (Short to V_{CC} , Short to GND, Short Between Outputs)**
- **Third-Generation Modulation Technique:**
 - Replaces Large LC Filter With Small, Low-Cost Ferrite Bead Filter in Most Applications
 - Improved Efficiency
 - Improved SNR
- **Low Supply Current: 8 mA Typ at 12 V**
- **Shutdown Control: < 1 μ A Typ**
- **Space-Saving, Thermally-Enhanced PowerPAD™ Packaging**

APPLICATIONS

- LCD Monitors/TVs
- Hands-Free Car Kits
- Powered Speakers

DESCRIPTION

The TPA3001D1 (sometimes referred to as TPA3001) is a 20-W monaural bridge-tied load (BTL) class-D audio power amplifier (class-D amp) with high efficiency, eliminating the need for heat sinks. The TPA3001D1 can drive 4-Ω or 8-Ω speakers with only a ferrite bead filter required to reduce EMI.

The gain of the amplifier is controlled by two input terminals, GAIN1 and GAIN0. This allows the amplifier to be configured for a gain of 12, 18, 23.6, or 36 dB. The differential input stage provides high common-mode rejection and improved power-supply rejection.

The amplifier also includes depop circuitry to reduce the amount of pop at power-up and when cycling SHUTDOWN.

The TPA3001D1 (TPA3001) is available in the 24-pin thermally enhanced TSSOP package (PWP), which eliminates the need for an external heat sink.

**EFFICIENCY
vs
OUTPUT POWER**

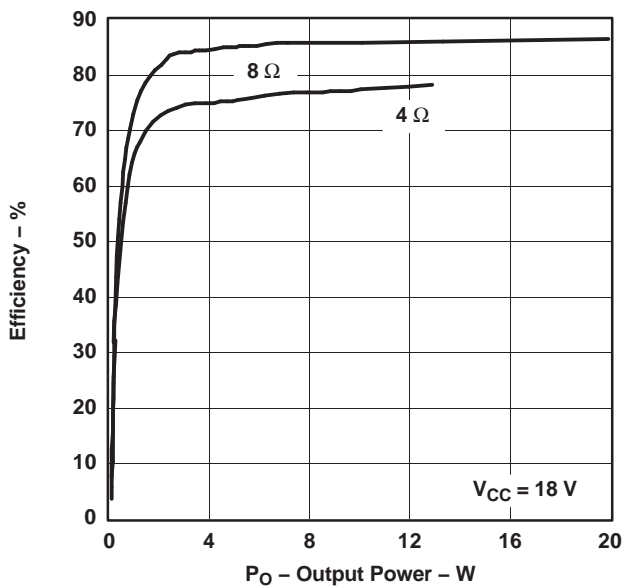

**MAXIMUM OUTPUT POWER
vs
LOAD IMPEDANCE**

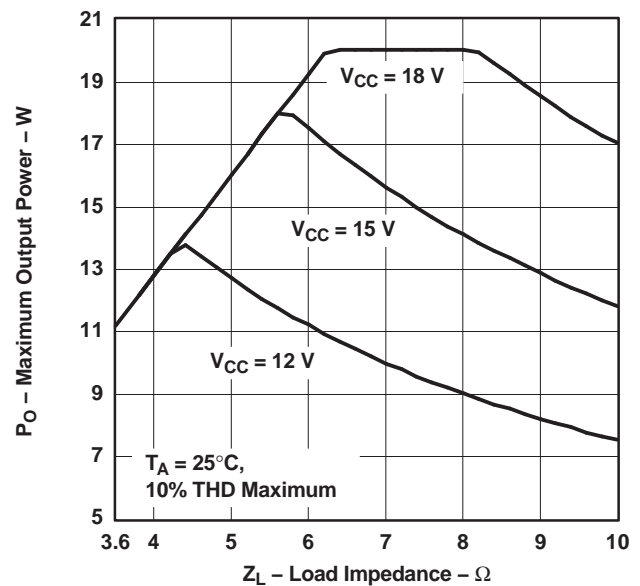

Please be aware that an important notice concerning availability, standard warranty, and use in critical applications of Texas Instruments semiconductor products and disclaimers thereto appears at the end of this data sheet.

PowerPAD is a trademark of Texas Instruments.

All other trademarks are the property of their respective owners.



These devices have limited built-in ESD protection. The leads should be shorted together or the device placed in conductive foam during storage or handling to prevent electrostatic damage to the MOS gates.

AVAILABLE OPTIONS⁽¹⁾

T_A	PACKAGED DEVICES
	TSSOP (PWP)⁽²⁾
–40°C to 85°C	TPA3001D1PWP

- (1) For the most current package and ordering information, see the Package Option Addendum at the end of this document, or see the TI Web site at www.ti.com.
- (2) The PWP package is available taped and reeled. To order a taped and reeled part, add the suffix R to the part number (e.g., TPA3001D1PWPR).

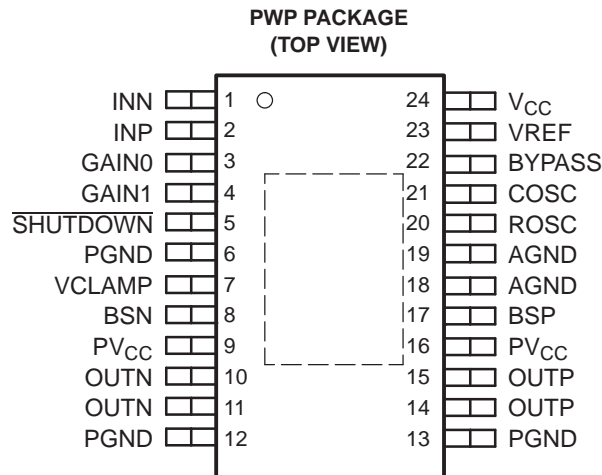

Pin Functions

NAME	PIN NO.	I/O	DESCRIPTION
AGND	18, 19		Analog ground terminal
BSN	8	I	Bootstrap terminal for high-side gate drive of negative BTL output (connect a 0.22- μ F capacitor with a 51- Ω resistor in series from OUTN to BSN)
BSP	17	I	Bootstrap terminal for high-side gate drive of positive BTL output (connect a 0.22- μ F capacitor with a 51- Ω resistor in series from OUTP to BSP)
BYPASS	22	I	Connect 1- μ F capacitor to ground for BYPASS voltage filtering
COSC	21	I	Connect a 220-pF capacitor to ground to set oscillation frequency
GAIN0	3	I	Bit 0 of gain control (see Table 1 for gain settings)
GAIN1	4	I	Bit 1 of gain control (see Table 1 for gain settings)
INN	1	I	Negative differential input
INP	2	I	Positive differential input
OUTN	10, 11	O	Negative BTL output, connect Schottky diode from PGND to OUTN for short-circuit protection
OUTP	14, 15	O	Positive BTL output, connect Schottky diode from PGND to OUTP for short-circuit protection
PGND	6, 12, 13		Power ground
PV _{CC}	9, 16	I	High-voltage power supply (for output stages)
ROSC	20	I	Connect a 120-k Ω resistor to ground to set oscillation frequency
SHUTDOWN	5	I	Shutdown terminal (negative logic), TTL compatible, 21-V compliant
V _{CC}	24	I	Analog high-voltage power supply
VCLAMP	7	O	Connect 1- μ F capacitor to ground to provide reference voltage for H-bridge gates
VREF	23	O	5-V internal regulator for control circuitry (connect a 0.1- μ F to 1- μ F capacitor to ground)
Thermal pad	–	–	Connect to AGND and PGND – should be star point for both grounds. Internal resistive connection to AGND. Thermal vias on the PCB should connect this pad to a large copper area on an internal or bottom layer for the best thermal performance. <i>The PAD must be soldered to the PCB for mechanical reliability.</i>

FUNCTIONAL BLOCK DIAGRAM

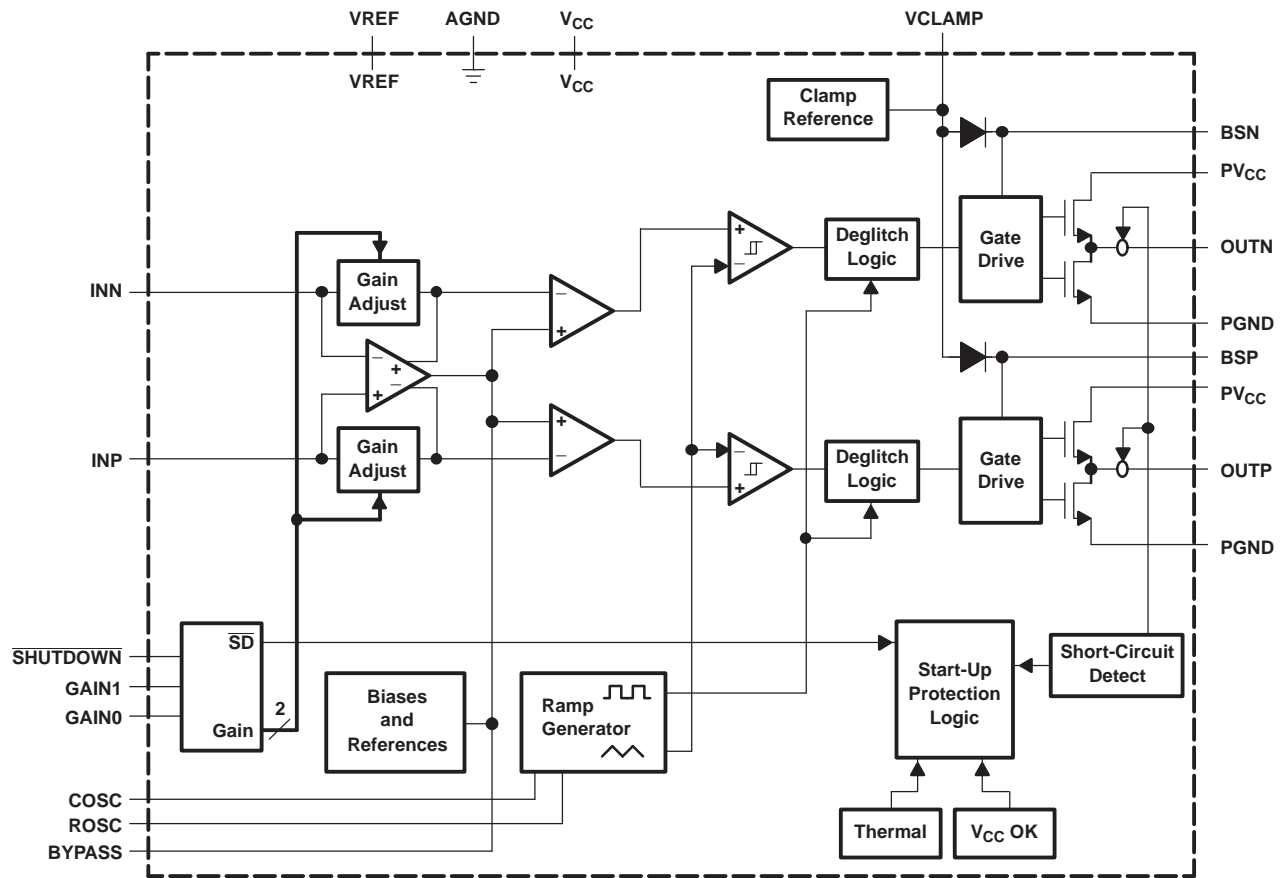

ABSOLUTE MAXIMUM RATINGS

over operating free-air temperature range (unless otherwise noted)⁽¹⁾

		UNIT
Supply voltage: V_{CC} , PV_{CC}		-0.3 V to 21 V
Load impedance, Z_L		$\geq 3.6 \Omega$
Input voltage	SHUTDOWN	-0.3 V to $V_{CC} + 0.3$ V
	GAIN0, GAIN1	-0.3 V to 5.5 V
	INN, INP	-0.3 V to 7 V
Continuous total power dissipation		See the Thermal Information Table
Operating free-air temperature range, T_A		-40°C to 85°C
Operating junction temperature range, T_J		-40°C to 150°C
Storage temperature range, T_{stg}		-65°C to 150°C

(1) Stresses beyond those listed under *Absolute Maximum Ratings* may cause permanent damage to the device. These are stress ratings only, and functional operation of the device at these or any other conditions beyond those indicated under *Recommended Operating Conditions* is not implied. Exposure to absolute-maximum-rated conditions for extended periods may affect device reliability.

THERMAL INFORMATION

THERMAL METRIC ⁽¹⁾⁽²⁾		TPA3001D1	UNITS
		PWP (24 Pins)	
θ_{JA}	Junction-to-ambient thermal resistance	36.2	°C/W
θ_{JCTop}	Junction-to-case (top) thermal resistance	32	
θ_{JB}	Junction-to-board thermal resistance	15.2	
ψ_{JT}	Junction-to-top characterization parameter	0.9	
ψ_{JB}	Junction-to-board characterization parameter	8.4	
θ_{JCbott}	Junction-to-case (bottom) thermal resistance	1.2	

(1) For more information about traditional and new thermal metrics, see the *IC Package Thermal Metrics* application report, [SPRA953](#).

(2) For thermal estimates of this device based on PCB copper area, see the [TI PCB Thermal Calculator](#).

RECOMMENDED OPERATING CONDITIONS

		MIN	MAX	UNIT
Supply voltage, V_{CC} , PV_{CC}	$Z_L \geq 3.6 \Omega$ ⁽¹⁾	8	18	V
Load impedance, Z_L		3.6		Ω
High-level input voltage, V_{IH}	GAIN0, GAIN1, SHUTDOWN	2		V
Low-level input voltage, V_{IL}	GAIN0, GAIN1, SHUTDOWN		0.8	V
Operating free-air temperature, T_A		-40	85	°C

(1) The TPA3001D1 must not be used with any speaker or load (including speaker with output filter) that could vary below 3.6 Ω over the audio frequency band.

ELECTRICAL CHARACTERISTICS

$T_A = 25^\circ\text{C}$, $PV_{CC} = V_{CC} = 12\text{ V}$ (unless otherwise noted)

PARAMETERS		TEST CONDITIONS	MIN	TYP	MAX	UNIT
$ V_{OS} $	Output offset voltage (measured differentially)	$V_I = 0\text{ V}$, $A_V = 12, 18, 23.6\text{ dB}$			50	mV
		$V_I = 0\text{ V}$, $A_V = 36\text{ dB}$			100	
PSRR	Power supply rejection ratio	$PV_{CC} = 11.5\text{ V to }12.5\text{ V}$		-73		dB
$ I_{IH} $	High-level input current	$PV_{CC} = 12\text{ V}$, $V_I = PV_{CC}$			1	μA
$ I_{IL} $	Low-level input current	$PV_{CC} = 12\text{ V}$, $V_I = 0\text{ V}$			1	μA
I_{CC}	Supply current	SHUTDOWN = 2 V, no load		8	15	mA
		SHUTDOWN = V_{CC} , $V_{CC} = 18\text{ V}$, $P_O = 20\text{ W}$, $R_L = 8\ \Omega$		1.3		A
$I_{CC(SD)}$	Supply current, shutdown mode	SHUTDOWN = 0.8 V		1	2	μA
f_s	Switching frequency	$R_{OSC} = 120\text{ k}\Omega$, $C_{OSC} = 220\text{ pF}$		250		kHz
$r_{ds(on)}$	Output transistor on resistance (total)	$I_O = 1\text{ A}$, $T_J = 25^\circ\text{C}$	0.2	0.3	0.7	Ω
G	Gain	GAIN1 = 0.8 V, GAIN0 = 0.8 V	10.9	12	12.8	dB
		GAIN1 = 0.8 V, GAIN0 = 2 V	17.1	18	18.7	dB
		GAIN1 = 2 V, GAIN0 = 0.8 V	22.7	23.6	24.3	dB
		GAIN1 = 2 V, GAIN0 = 2 V	34.9	36	36.7	dB

OPERATING CHARACTERISTICS

$PV_{CC} = V_{CC} = 12\text{ V}$, $T_A = 25^\circ\text{C}$ (unless otherwise noted)

PARAMETER		TEST CONDITIONS	MIN	TYP	MAX	UNIT
P_O	Continuous output power at 10% THD+N	$f = 1\text{ kHz}$, $R_L = 4\ \Omega$		12.8		W
		$f = 1\text{ kHz}$, $R_L = 8\ \Omega$		9		
	Continuous output power at 1% THD+N	$f = 1\text{ kHz}$, $R_L = 4\ \Omega$		10.3		
		$f = 1\text{ kHz}$, $R_L = 8\ \Omega$		7.2		
THD+N	Total harmonic distortion plus noise	$P_O = 10\text{ W}$, $R_L = 4\ \Omega$, $f = 20\text{ Hz to }20\text{ kHz}$		0.2%		
B_{OM}	Maximum output-power bandwidth	THD = 1%		20		kHz

OPERATING CHARACTERISTICS (continued)
 $PV_{CC} = V_{CC} = 12\text{ V}$, $T_A = 25^\circ\text{C}$ (unless otherwise noted)

PARAMETER		TEST CONDITIONS	MIN	TYP	MAX	UNIT
k_{SVR}	Supply ripple rejection ratio	$f = 1\text{ kHz}$, $C_{(BYPASS)} = 1\ \mu\text{F}$		-70		dB
SNR	Signal-to-noise ratio	$P_O = 10\text{ W}$, $R_L = 4\ \Omega$		95		dB
V_n	Noise output voltage	$C_{(BYPASS)} = 1\ \mu\text{F}$, $f = 20\text{ Hz to } 22\text{ kHz}$, no weighting filter used, gain = 12 dB		86		$\mu\text{V(rms)}$
				-81		dBV
V_n	Noise output voltage	$C_{(BYPASS)} = 1\ \mu\text{F}$, $f = 20\text{ Hz to } 22\text{ kHz}$, A-weighted filter, gain = 12 dB		66		$\mu\text{V(rms)}$
				-84		dBV
Z_I	Input impedance	See Table 1 .		> 23		k Ω

OPERATING CHARACTERISTICS
 $PV_{CC} = V_{CC} = 18\text{ V}$, $T_A = 25^\circ\text{C}$ (unless otherwise noted)

PARAMETER		TEST CONDITIONS	MIN	TYP	MAX	UNIT
P_O	Output power at 10% THD+N	$f = 1\text{ kHz}$, $R_L = 4\ \Omega$		12.8		W
		$f = 1\text{ kHz}$, $R_L = 8\ \Omega$		20		
	Output power at 1% THD+N	$f = 1\text{ kHz}$, $R_L = 4\ \Omega$		10.3		
		$f = 1\text{ kHz}$, $R_L = 8\ \Omega$		16		
THD+N	Total harmonic distortion plus noise	$P_O = 15\text{ W}$, $R_L = 8\ \Omega$, $f = 20\text{ Hz to } 20\text{ kHz}$		1%		
		$P_O = 2\text{ W}$, $R_L = 8\ \Omega$, $f = 20\text{ Hz to } 20\text{ kHz}$		0.3%		
B_{OM}	Maximum output-power bandwidth	THD = 1%		20		kHz
k_{SVR}	Supply ripple rejection ratio	$f = 1\text{ kHz}$, $C_{BYPASS} = 1\ \mu\text{F}$		-70		dB
SNR	Signal-to-noise ratio	$P_O = 15\text{ W}$, $R_L = 8\ \Omega$		102		dB
V_n	Noise output voltage	$C_{(BYPASS)} = 1\ \mu\text{F}$, $f = 20\text{ Hz to } 20\text{ kHz}$, no weighting filter used, gain = 12 dB		86		$\mu\text{V(rms)}$
				-81		dBV
V_n	Noise output voltage	$C_{(BYPASS)} = 1\ \mu\text{F}$, $f = 20\text{ Hz to } 22\text{ kHz}$, A-weighted filter, gain = 12 dB		66		$\mu\text{V(rms)}$
				84		dBV
Z_I	Input impedance	See Table 1 .		>23		k Ω

TYPICAL CHARACTERISTICS
Table of Graphs

			FIGURE
	Efficiency	vs Output power	1
P_O	Maximum output power	vs Load impedance	2, 3, 4
I_{CC}	Supply current	vs Supply voltage	5
$I_{CC(SD)}$	Shutdown current		6
THD+N	Total harmonic distortion + noise	vs Output power	7, 8, 9, 10, 11, 12, 13, 14, 15, 16, 17, 18
		vs Frequency	19, 20, 21, 22, 23, 24, 25
k_{SVR}	Supply voltage rejection ratio	vs Frequency	26
	Gain and phase		27
CMRR	Common-mode rejection ratio		28
V_{IO}	Input offset voltage	vs Common-mode input voltage	29

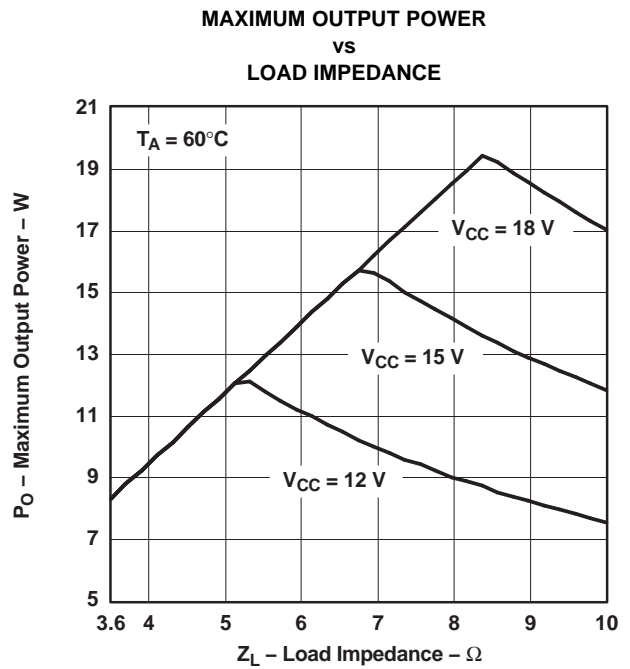
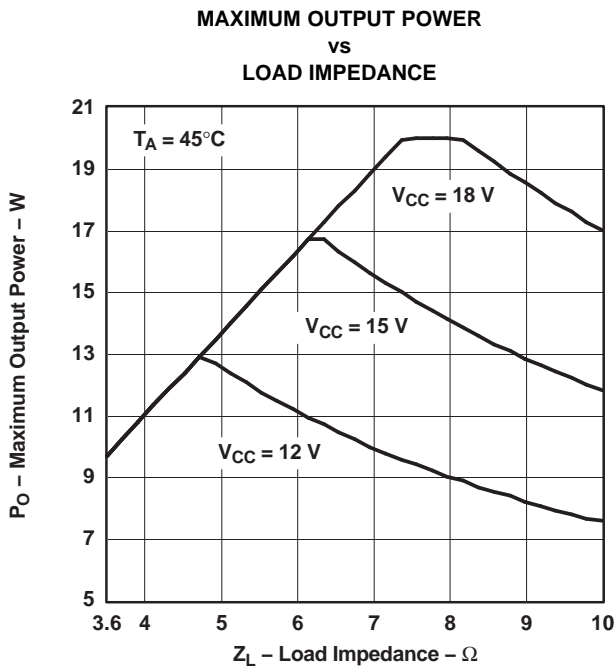
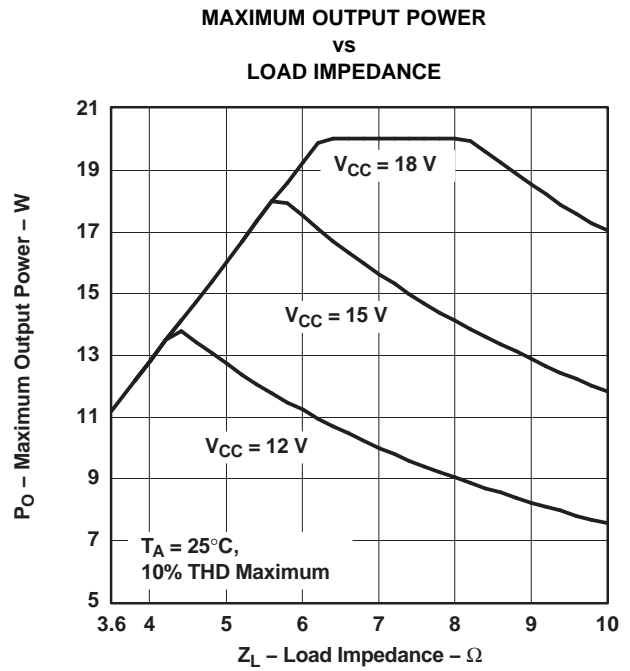
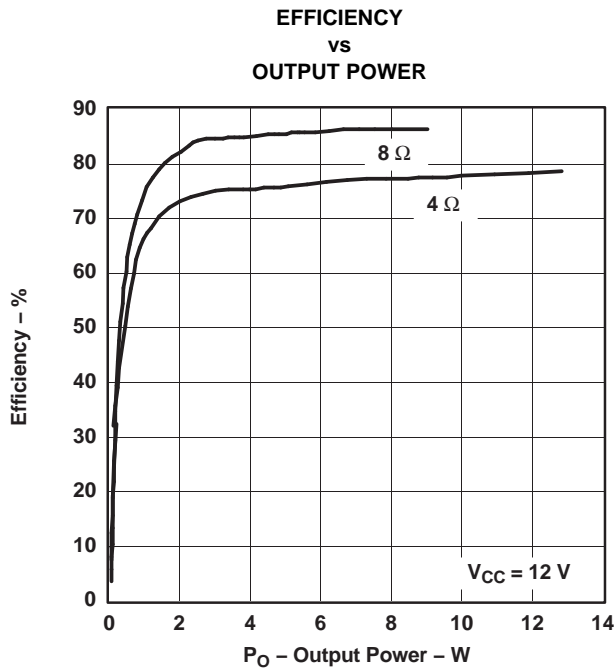

**SUPPLY CURRENT
vs
SUPPLY VOLTAGE**

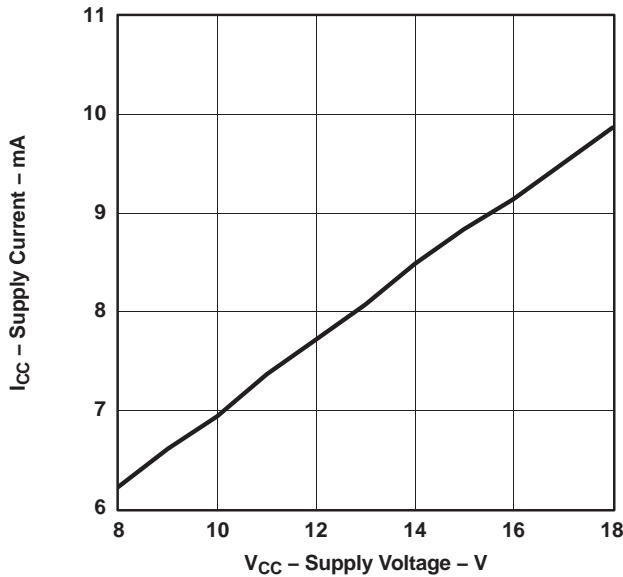

Figure 5.

**SHUTDOWN CURRENT
vs
SUPPLY VOLTAGE**

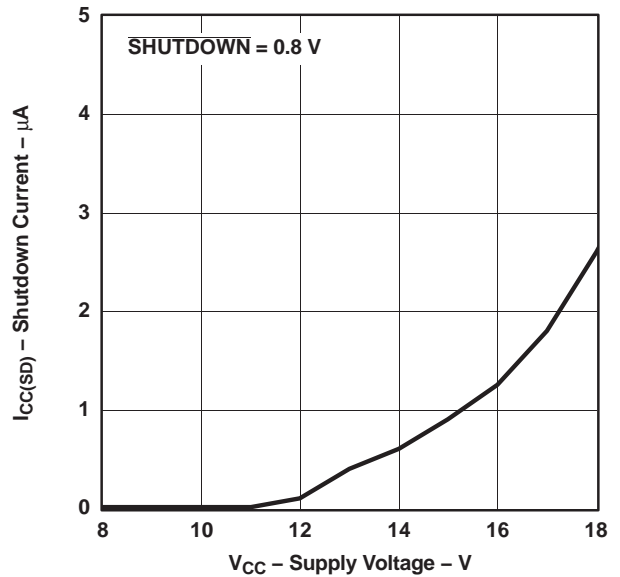

Figure 6.

**TOTAL HARMONIC DISTORTION + NOISE
vs
OUTPUT POWER**

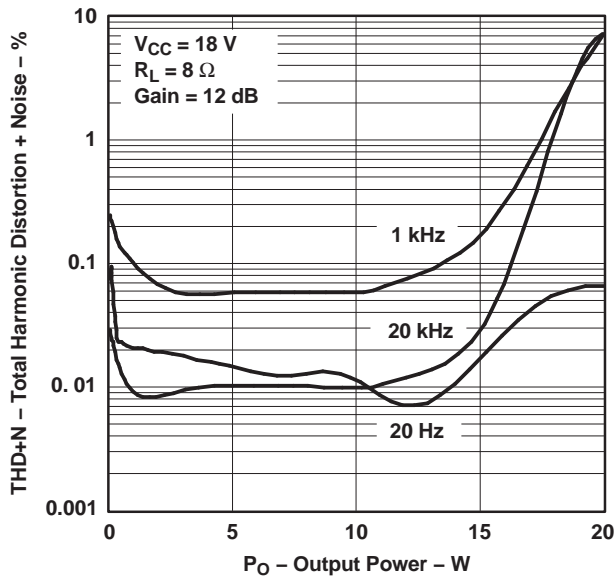

Figure 7.

**TOTAL HARMONIC DISTORTION + NOISE
vs
OUTPUT POWER**

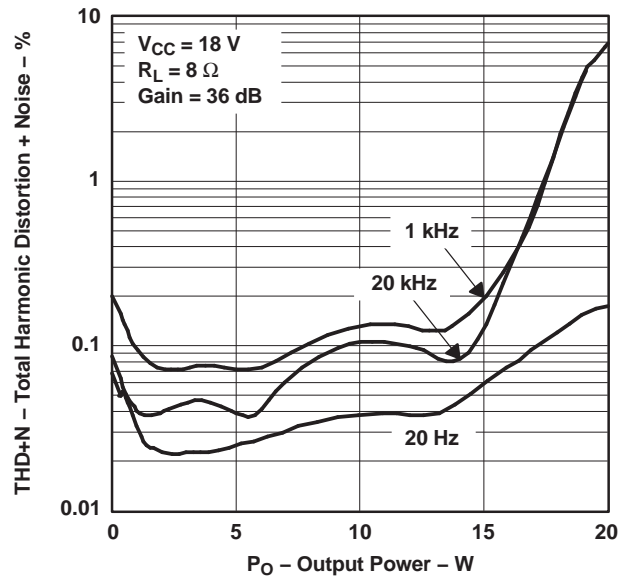

Figure 8.

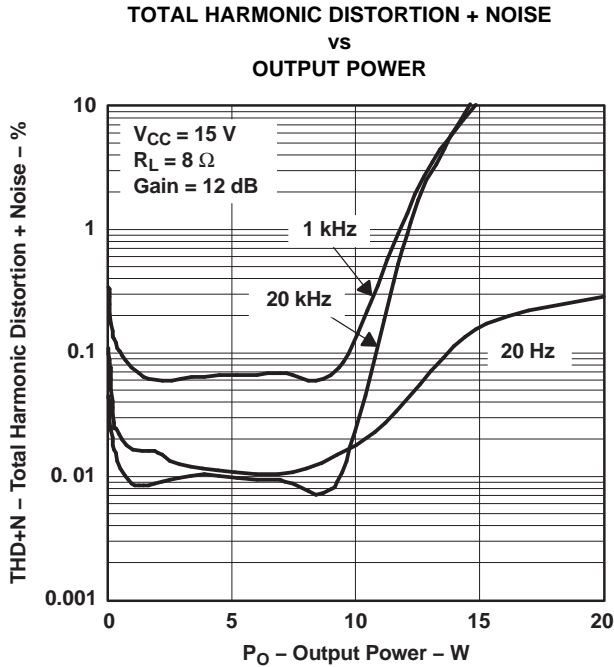

Figure 9.

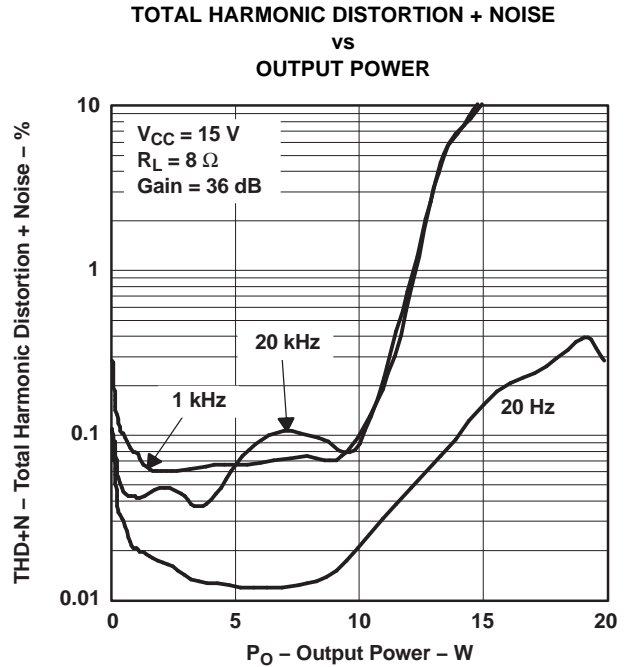

Figure 10.

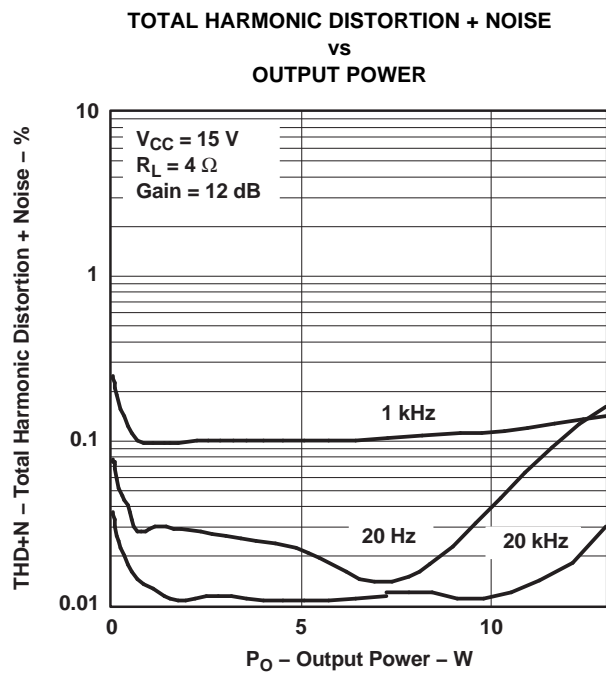

Figure 11.

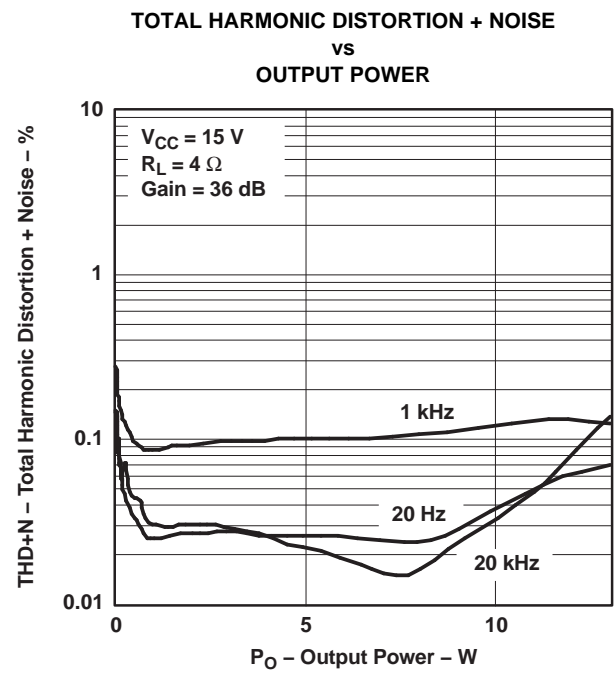

Figure 12.

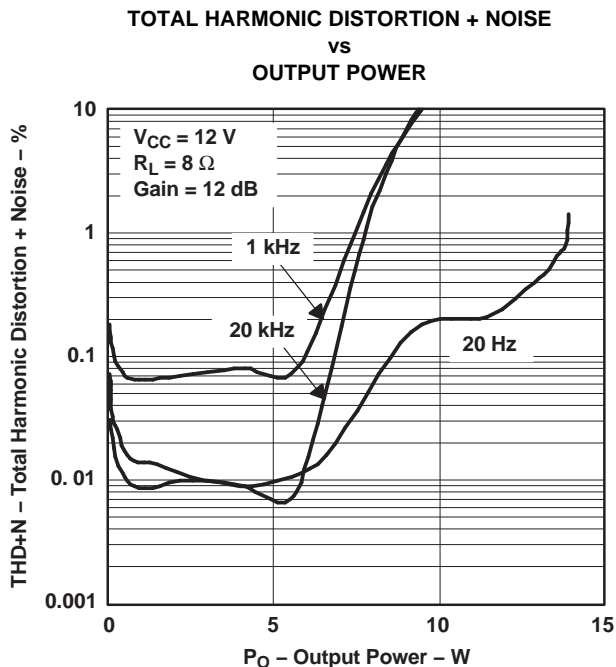

Figure 13.

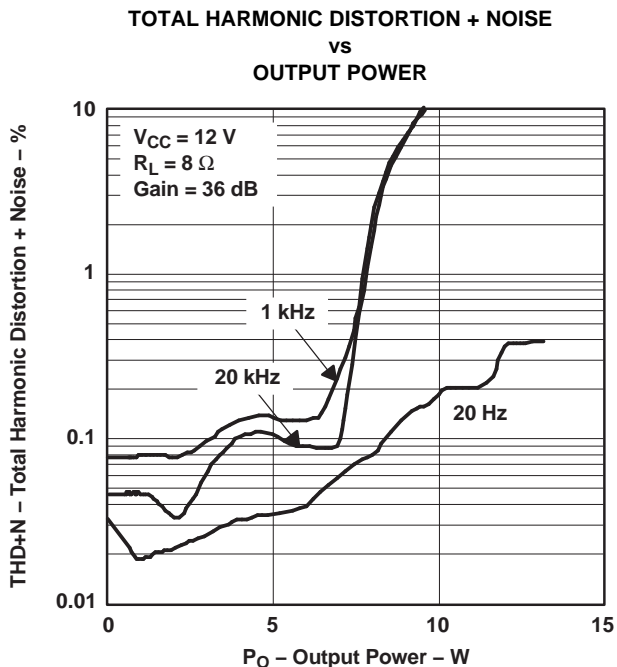

Figure 14.

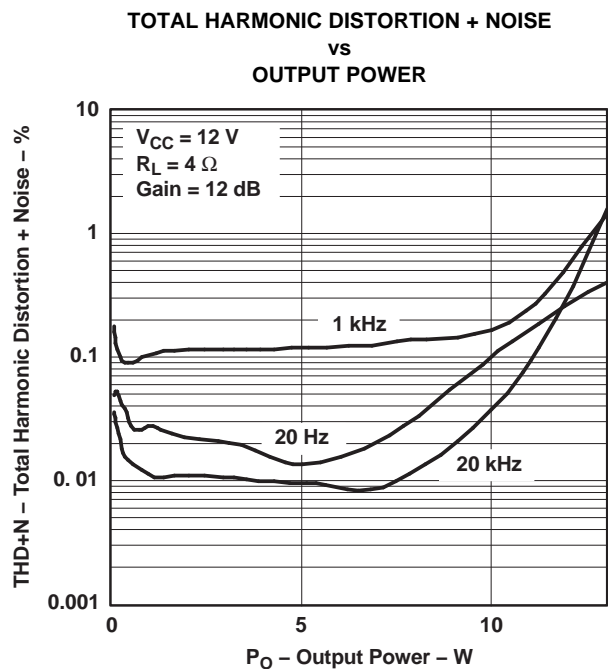

Figure 15.

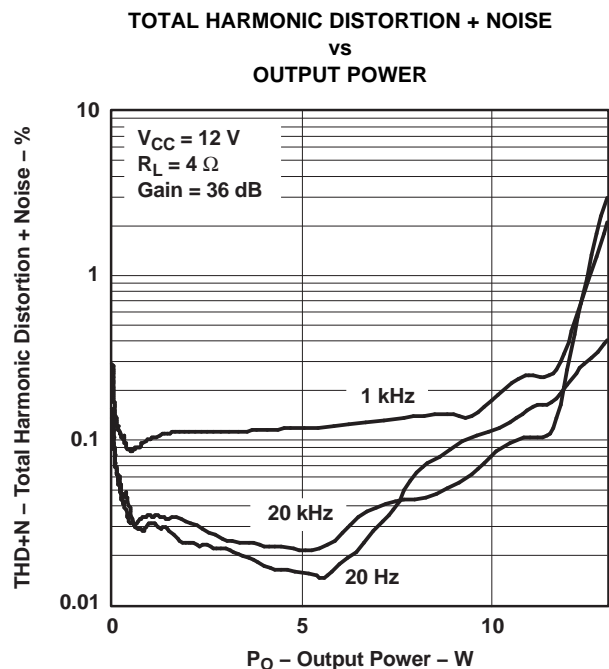

Figure 16.

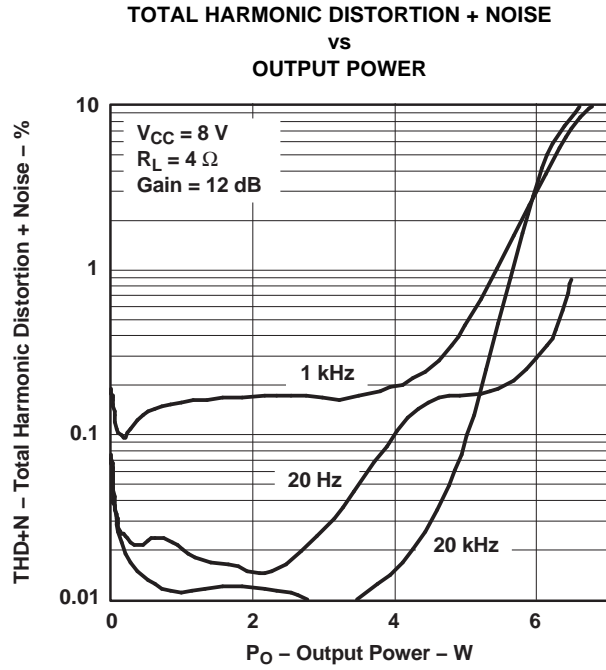

Figure 17.

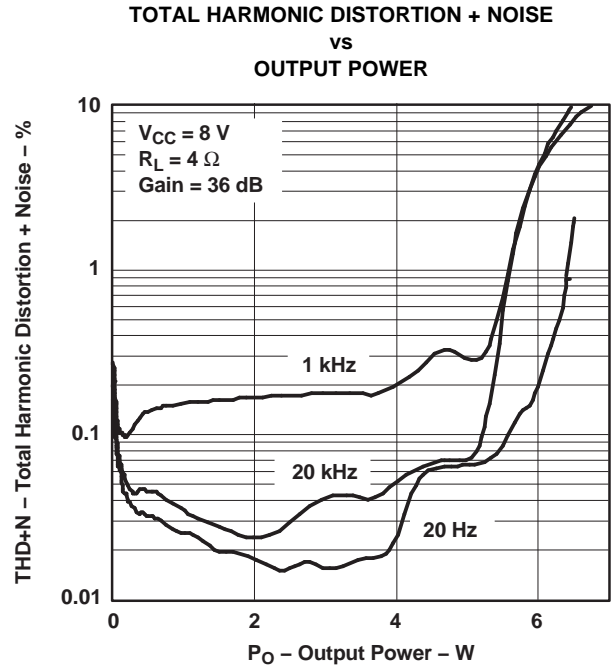

Figure 18.

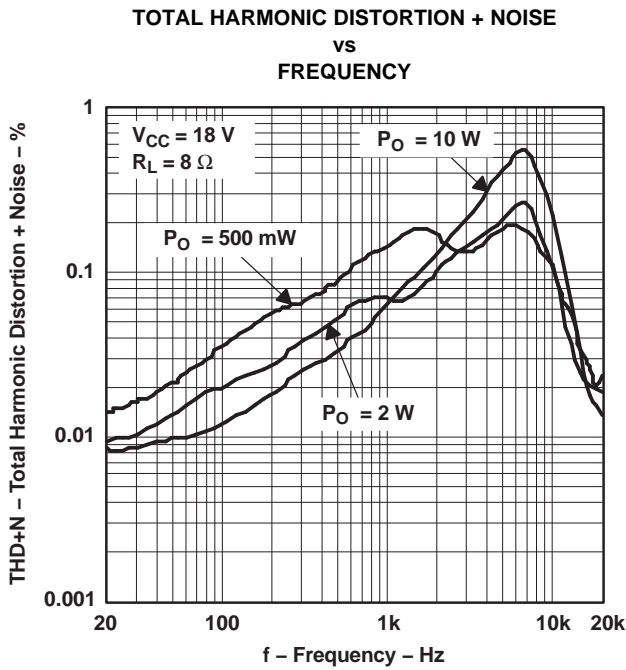

Figure 19.

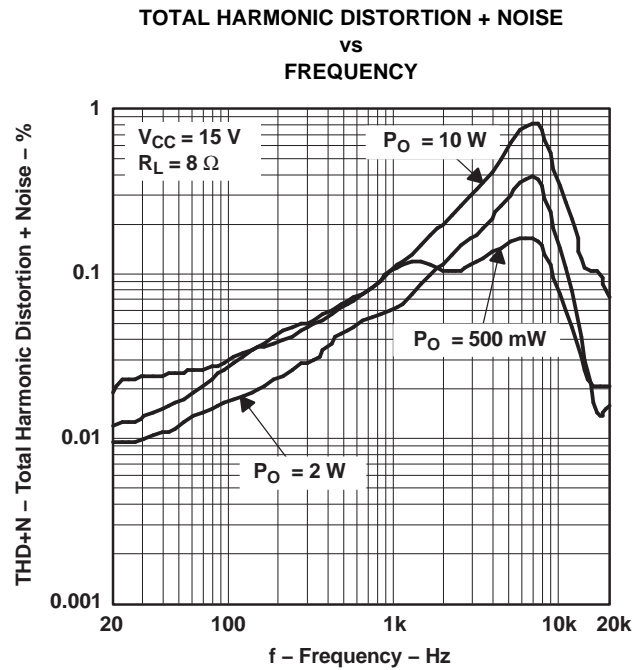

Figure 20.

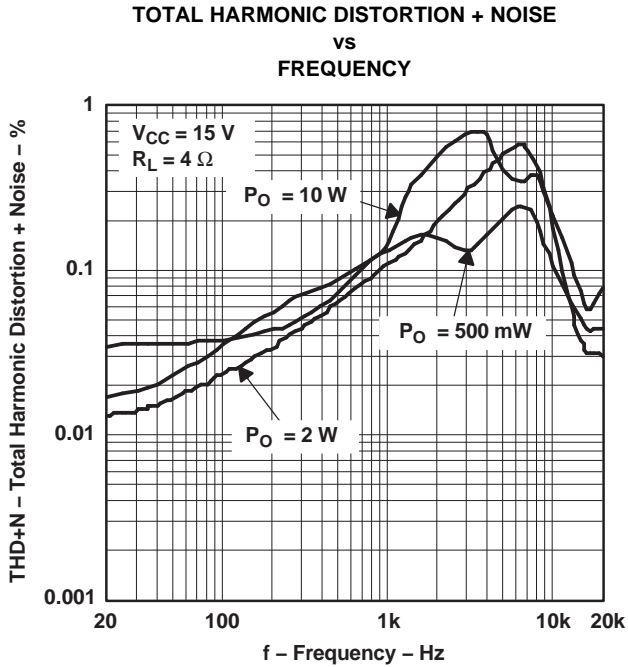

Figure 21.

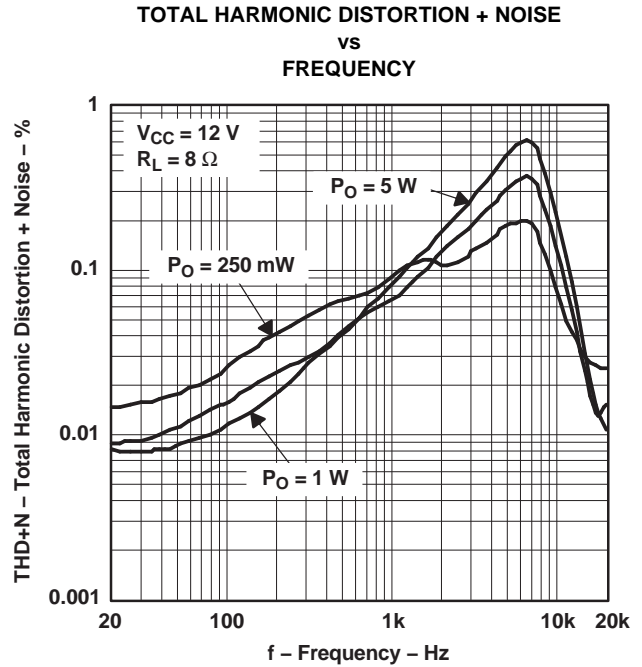

Figure 22.

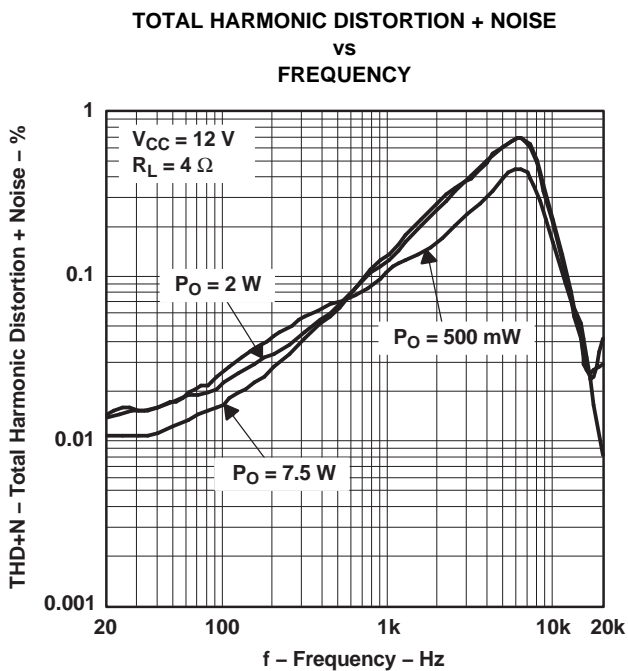

Figure 23.

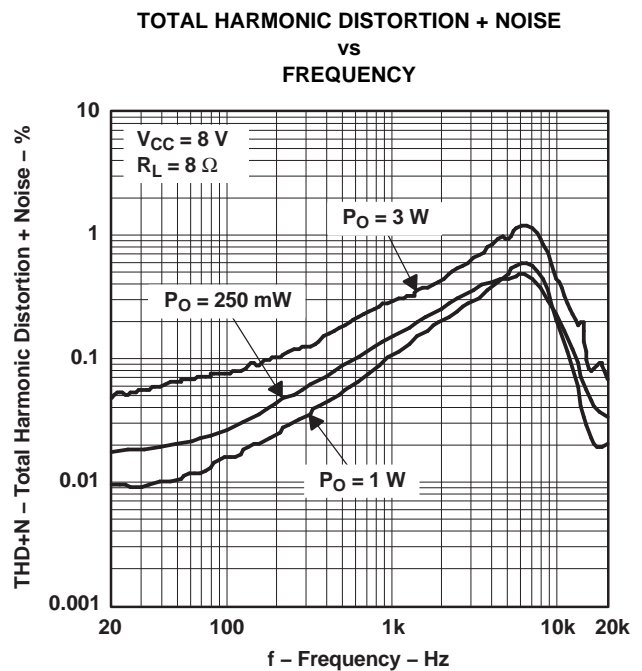

Figure 24.

**TOTAL HARMONIC DISTORTION + NOISE
vs
FREQUENCY**

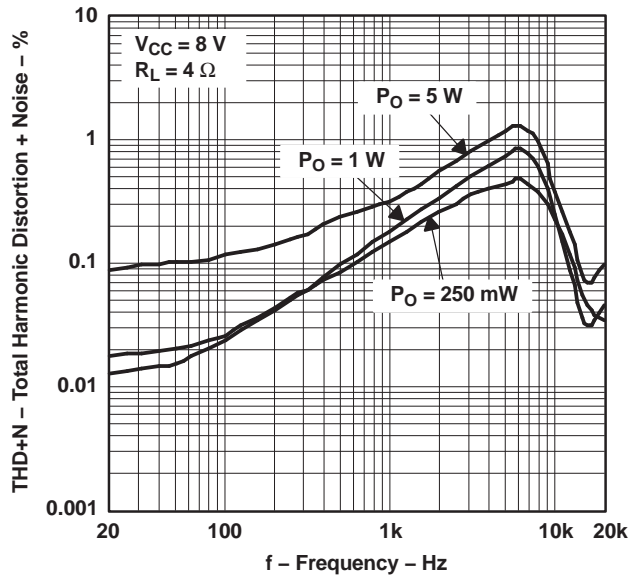

Figure 25.

**SUPPLY VOLTAGE REJECTION RATIO
vs
FREQUENCY**

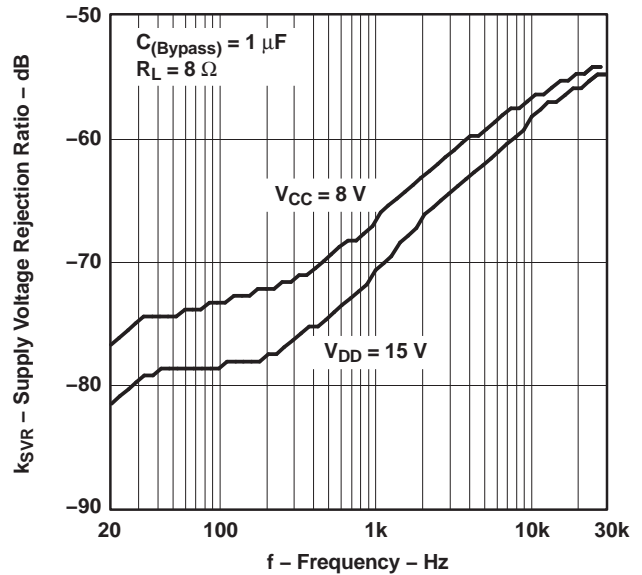

Figure 26.

**GAIN AND PHASE
vs
FREQUENCY**

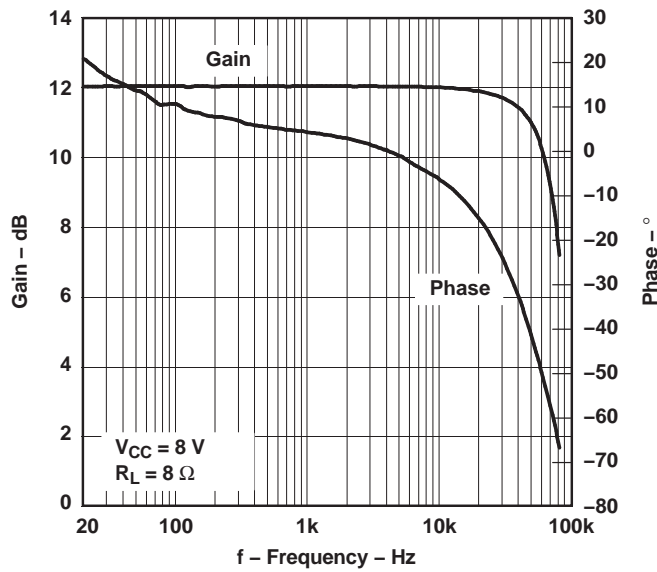

Figure 27.

**COMMON-MODE REJECTION RATIO
vs
FREQUENCY**

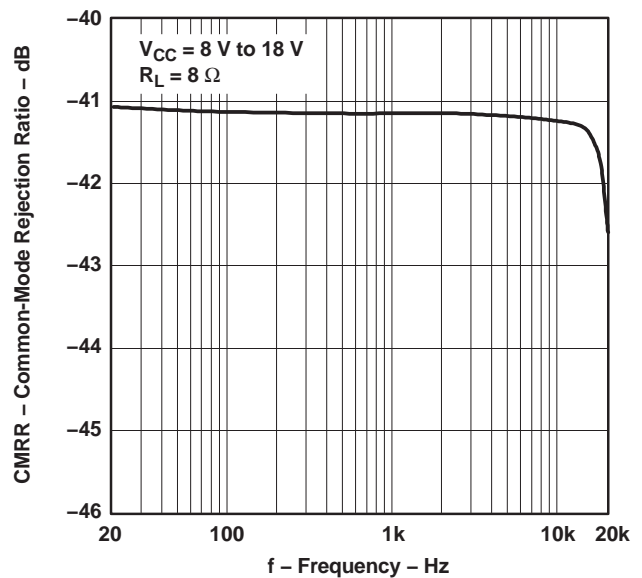
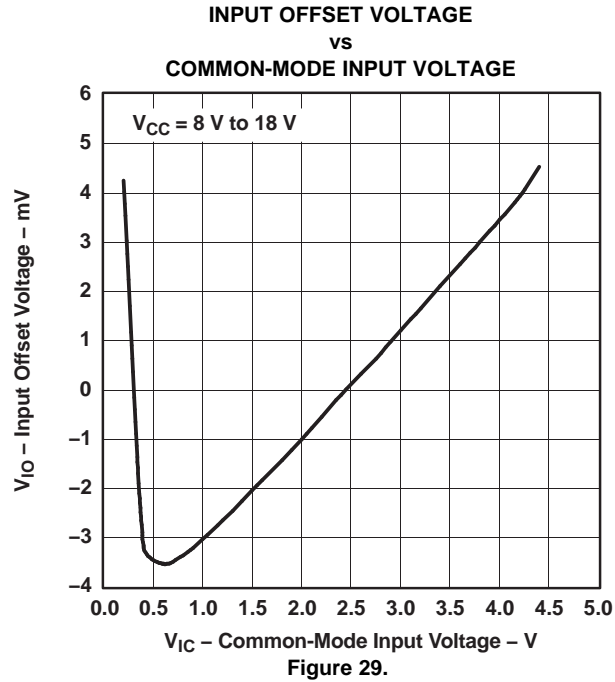

Figure 28.



APPLICATION INFORMATION

APPLICATION CIRCUIT

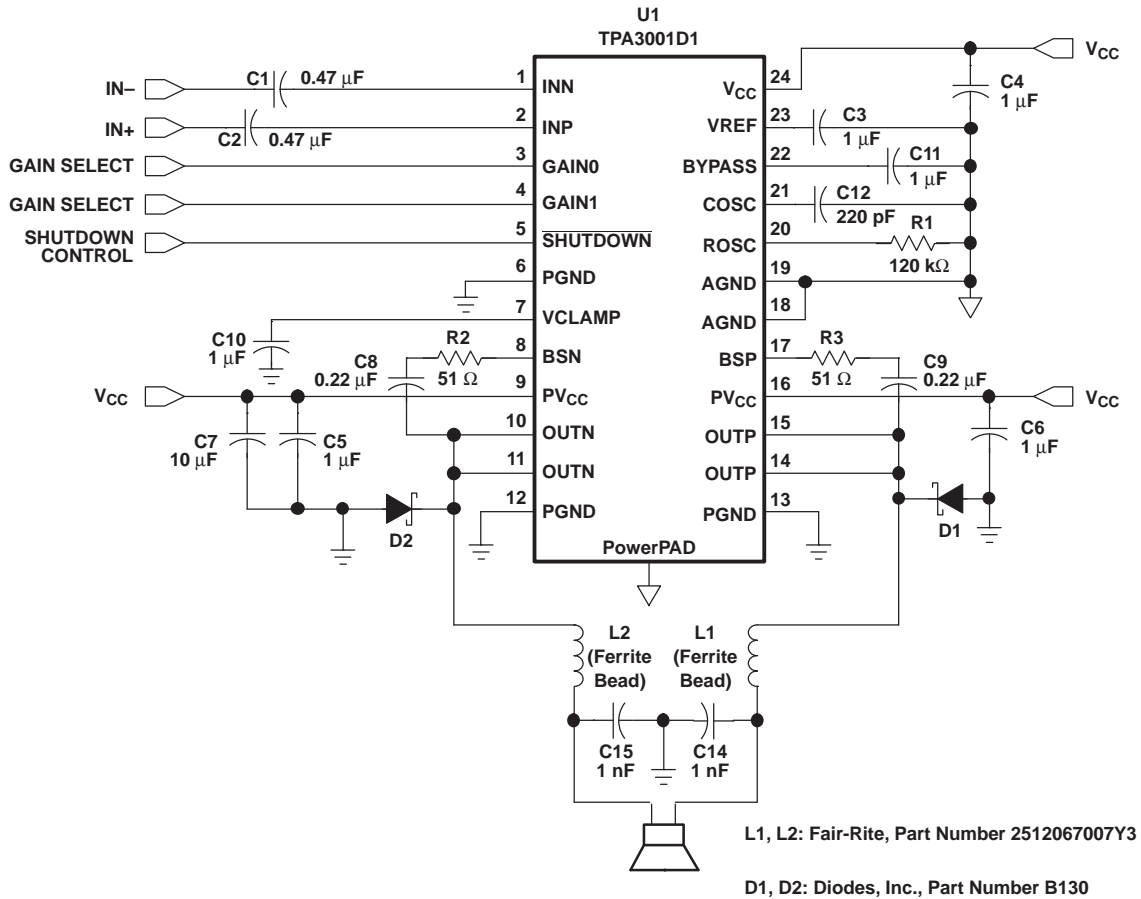

Figure 30. Typical Application Circuit

CLASS-D OPERATION

This section focuses on the class-D operation of the TPA3001D1.

TRADITIONAL CLASS-D MODULATION SCHEME

The traditional class-D modulation scheme, which is used in the TPA032D0x family, has a differential output where each output is 180 degrees out of phase and changes from ground to the supply voltage, V_{CC} . Therefore, the differential prefiltered output varies between positive and negative V_{CC} , where filtered 50% duty cycle yields 0 V across the load. The traditional class-D modulation scheme with voltage and current waveforms is shown in [Figure 31](#). Note that even at an average of 0 V across the load (50% duty cycle), the current to the load is high, causing high loss, thus causing a high supply current.

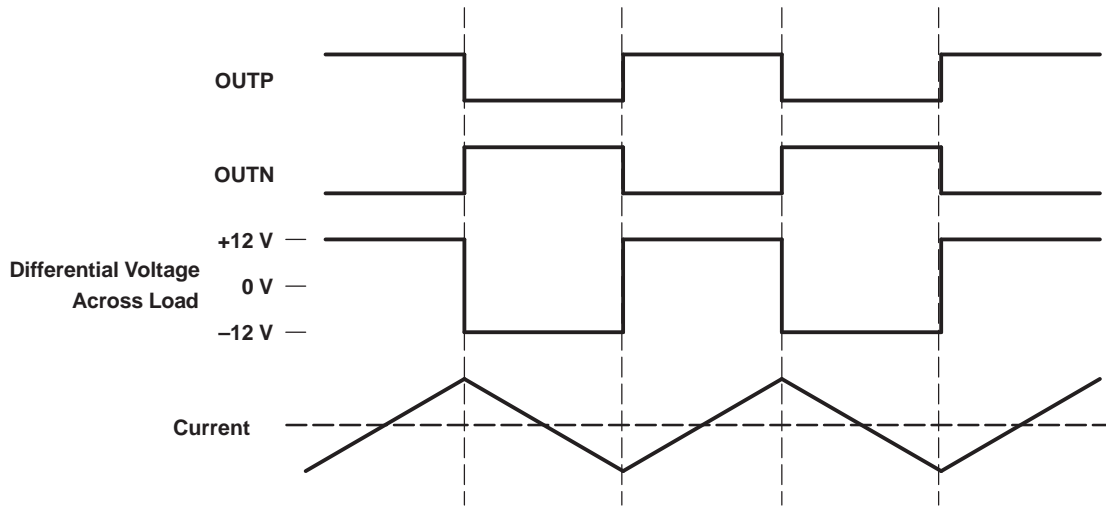

Figure 31. Traditional Class-D Modulation Scheme's Output Voltage and Current Waveforms Into an Inductive Load With No Input

TPA3001D1 MODULATION SCHEME

The TPA3001D1 uses a modulation scheme that still has each output switching from ground to V_{CC} . However, OUTP and OUTN are now in phase with each other with no input. The duty cycle of OUTP is greater than 50% and OUTN is less than 50% for positive output voltages. The duty cycle of OUTP is less than 50% and OUTN is greater than 50% for negative output voltages. The voltage across the load is 0 V throughout most of the switching period, greatly reducing the switching current, which reduces any I^2R losses in the load. (See [Figure 32.](#))

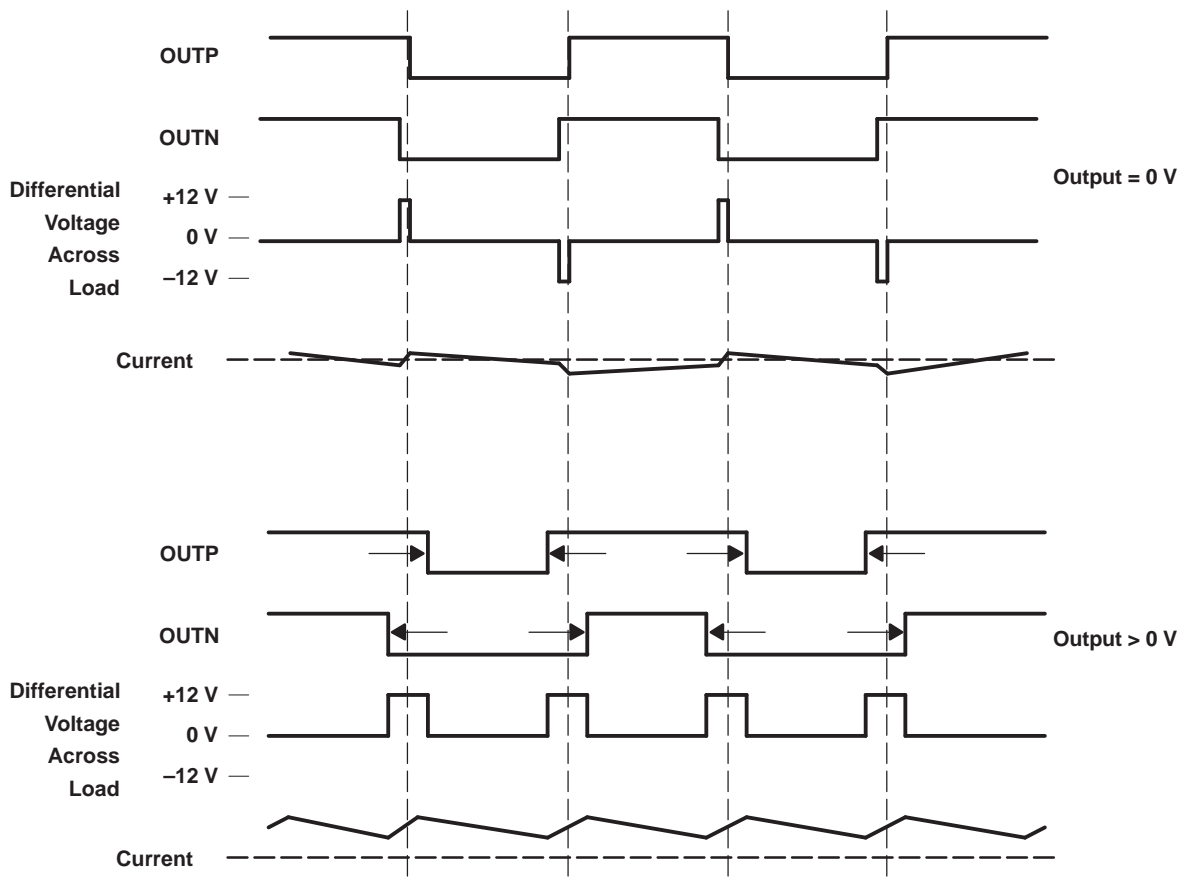

Figure 32. The TPA3001D1 Output Voltage and Current Waveforms Into an Inductive Load

MAXIMUM ALLOWABLE OUTPUT POWER (SAFE OPERATING AREA)

The TPA3001D1 can drive load impedances as low as 3.6 Ω from power supply voltages ranging from 8 V to 18 V. To prevent device failure, however, the output power of the TPA3001D1 must be limited. Figure 33 shows the maximum allowable output power versus load impedance for three power-supply voltages at an ambient temperature of 25°C. (For ambient temperatures of 45°C and 60°C, see Figure 3 and Figure 4.)

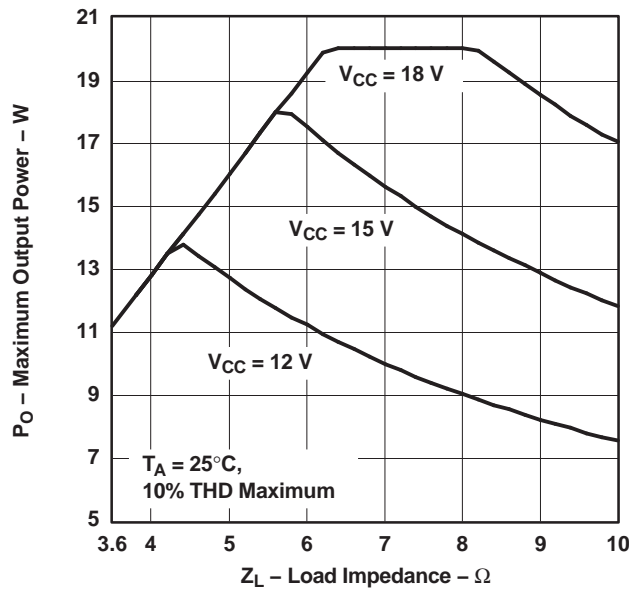

Figure 33. Output Power

DRIVING A LOW-IMPEDANCE LOAD FROM A HIGH POWER-SUPPLY VOLTAGE

When driving low-impedance loads (e.g., a 4-Ω speaker), the output power can be limited by reducing the maximum audio input signal level or by reducing the gain of the TPA3001D1. The maximum input voltage may be calculated with Equation 1.

$$V_{in(pp),max} = \frac{\sqrt{8P_{O(avg),max} \times Z_L}}{A_V} \quad (1)$$

where

$P_{O(avg),max}$ = maximum continuous output power (W)

Z_L = load impedance (Ω)

$$A_V = \text{voltage gain (V/V)} = \left(\frac{G(\text{dB})}{20} \right)$$

For example, consider an application in which the TPA3001D1 drives a 4-Ω speaker from an 18-V power supply. The gain is selected to be 18 dB. The maximum allowable output power for a 4-Ω load impedance is 12.8 W. From Equation 1, the input voltage must not exceed 2.54 V_{pp}.

In this same example, however, if the maximum output voltage of audio signal source is 5 V_{pp}, then the gain of the TPA3001D1 should be reduced to 12 dB to eliminate the need for limiting the input signal.

The input voltage may be limited using a variety of methods, depending on what is known about the audio signal source. If the maximum output voltage of the source is known, a resistive voltage divider in conjunction with proper TPA3001D1 gain selection may be used to prevent distortion. If the maximum audio source voltage is unknown, diodes may be used to clamp the input voltage, at the cost of distortion when the input signal level exceeds the required clamping voltage.

DRIVING THE OUTPUT INTO CLIPPING

The output of the TPA3001D1 may be driven into clipping to attain a higher output power than is possible with no distortion. Clipping is typically quantified by a THD measurement of 10%. The amount of additional power into the load may be calculated with Equation 2.

$$P_{O(10\% \text{ THD})} = P_{O(1\% \text{ THD})} \times 1.25 \quad (2)$$

For example, consider an application in which the TPA3001D1 drives an 8-Ω speaker from an 18-V power supply. The maximum output power with no distortion (less than 1% THD) is 16 W, which corresponds to a maximum peak output voltage of 16 V. For the same output voltage level driven into clipping (10% THD), the output power is increased to 20 W.

OUTPUT FILTER CONSIDERATIONS

A ferrite bead filter (shown in Figure 34) should be used in order to pass FCC and/or CE radiated emissions specifications and if a frequency-sensitive circuit operating higher than 1 MHz is nearby. The ferrite filter reduces EMI around 1 MHz and higher (FCC and CE only test radiated emissions greater than 30 MHz). When selecting a ferrite bead, choose one with high impedance at high frequencies, but very low impedance at low frequencies.

Use an additional LC output filter if there are low frequency (<1 MHz) EMI sensitive circuits and/or there are long wires (greater than 11 inches) from the amplifier to the speaker, as shown in Figure 35 and Figure 36.

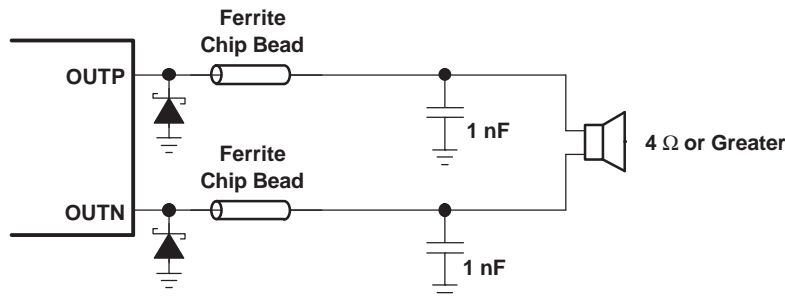

Figure 34. Typical Ferrite Chip Bead Filter (Chip Bead Example: Fair-Rite 2512067007Y3)

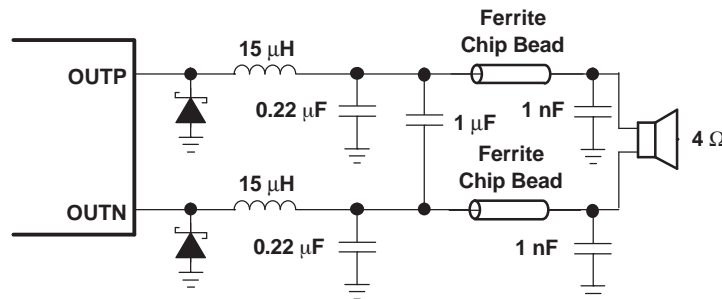

Figure 35. Typical LC Output Filter for 4-Ω Speaker, Cutoff Frequency of 27 kHz

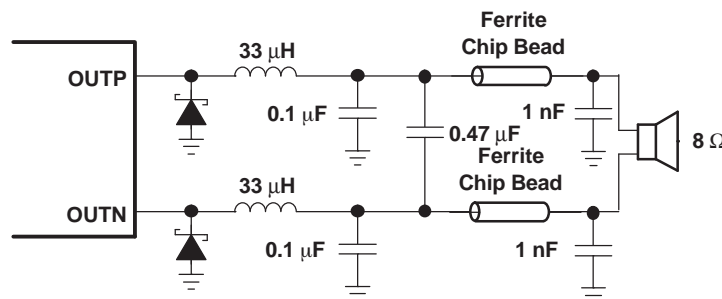

Figure 36. Typical LC Output Filter for 8-Ω Speaker, Cutoff Frequency of 27 kHz

SHORT-CIRCUIT PROTECTION

The TPA3001D1 has short-circuit protection circuitry on the outputs that prevents damage to the device during output-to-output shorts, output-to-GND shorts, and output-to- V_{CC} shorts. When a short-circuit is detected on the outputs, the part immediately disables the output drive and enters into shutdown mode. This is a latched fault and must be reset by cycling the voltage on the SHUTDOWN pin to a logic low and back to the logic high state for normal operation. This clears the short-circuit flag and allows for normal operation if the short was removed. If the short was not removed, the protection circuitry again activates.

Two Schottky diodes are required to provide short-circuit protection. The diodes should be placed as close to the TPA3001D1 as possible, with the anodes connected to PGND and the cathodes connected to OUTP and OUTN as shown in the application circuit schematic. The diodes should have a forward voltage rating of 0.5 V at a minimum of 1-A output current and a dc blocking voltage rating of at least 30 V. The diodes must also be rated to operate at a junction temperature of 150°C.

If short-circuit protection is not required, the Schottky diodes may be omitted.

THERMAL PROTECTION

Thermal protection on the TPA3001D1 prevents damage to the device when the internal die temperature exceeds 150°C. There is a $\pm 15^\circ\text{C}$ tolerance on this trip point from device to device. Once the die temperature exceeds the thermal set point, the device enters into the shutdown state and the outputs are disabled. This is not a latched fault. The thermal fault is cleared once the temperature of the die is reduced by 15°C. The device begins normal operation at this point with no external system interaction.

THERMAL CONSIDERATION: OUTPUT POWER AND MAXIMUM AMBIENT TEMPERATURE

To calculate the maximum ambient temperature, Equation 3 may be used:

$$T_{Amax} = T_{Jmax} - \theta_{JA} P_{Dissipated} \quad (3)$$

where: $T_{Jmax} = 150^\circ\text{C}$

$$\theta_{JA} = 1 / \text{derating factor} = 1 / 0.03333 = 30^\circ\text{C/W}$$

(The derating factor for the 24-pin PWP package is given in the dissipation rating table.)

To estimate the power dissipation, Equation 4 may be used:

$$P_{Dissipated} = P_{O(average)} \times ((1/\text{Efficiency}) - 1) \quad (4)$$

Efficiency = ~85% for an 8- Ω load or = ~75% for a 4- Ω load

Example: What is the maximum ambient temperature for an application that requires the TPA3001D1 to drive 10 W into an 8- Ω speaker?

$$P_{Dissipated} = 10 \text{ W} \times ((1 / 0.85) - 1) = 1.76 \text{ W}$$

$$T_{Amax} = 150^\circ\text{C} - (30^\circ\text{C/W} \times 1.76 \text{ W}) = 97.2^\circ\text{C}$$

This calculation shows that the TPA3001D1 can drive 10 W into an 8- Ω speaker up to the absolute maximum ambient temperature rating of 85°C, which must never be exceeded. Also, refer to Figure 2, Figure 3, and Figure 4 to determine the minimum load impedance for the desired output power.

GAIN SETTING VIA GAIN0 AND GAIN1 INPUTS

The gain of the TPA3001D1 is set by two input terminals, GAIN0 and GAIN1.

The gains listed in Table 1 are realized by changing the taps on the input resistors inside the amplifier. This causes the input impedance (Z_i) to be dependent on the gain setting. The actual gain settings are controlled by ratios of resistors, so the gain variation from part to part is small. However, the input impedance may shift by 30% due to shifts in the actual resistance of the input resistors.

For design purposes, the input network (discussed in the next section) should be designed assuming an input impedance of 23 k Ω , which is the absolute minimum input impedance of the TPA3001D1. At the lower gain settings, the input impedance could increase as high as 313 k Ω .

Table 1. Gain Settings

GAIN1	GAIN0	AMPLIFIER GAIN (dB)	INPUT IMPEDANCE (kΩ)
		TYP	TYP
0	0	12	241
0	1	18	168
1	0	23.6	104
1	1	36	33

INPUT RESISTANCE

Each gain setting is achieved by varying the input resistance of the amplifier, which can range from its smallest value to over six times that value. As a result, if a single capacitor is used in the input high-pass filter, the –3-dB or cutoff frequency also changes by over six times.

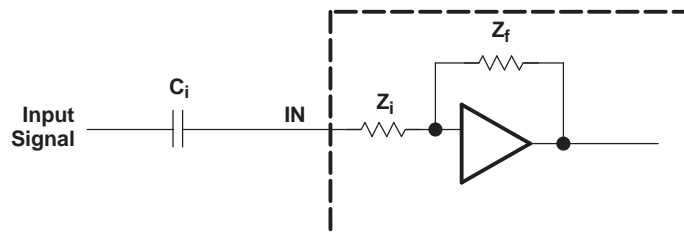

The –3-dB frequency can be calculated using Equation 5. Use Table 1 for Zi values.

$$f = \frac{1}{2\pi Z_i C_i} \tag{5}$$

INPUT CAPACITOR, Ci

In the typical application, an input capacitor (Ci) is required to allow the amplifier to bias the input signal to the proper dc level for optimum operation. In this case, Ci and the input impedance of the amplifier (Zi) form a high-pass filter with the corner frequency determined in Equation 6.

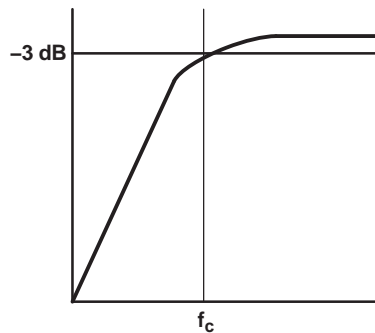

$$f_c = \frac{1}{2\pi Z_i C_i} \tag{6}$$

The value of Ci is important, as it directly affects the bass (low frequency) performance of the circuit. Consider the example where Zi is 241 kΩ and the specification calls for a flat bass response down to 20 Hz. Equation 6 is reconfigured as Equation 7.

$$C_i = \frac{1}{2\pi Z_i f_c} \tag{7}$$

In this example, C_1 is 33 nF, so one would likely choose a value of 0.1 μF , as this value is commonly used. If the gain is known and will be constant, use Z_1 from [Table 1](#) to calculate C_1 . A further consideration for this capacitor is the leakage path from the input source through the input network (C_1) and the feedback network to the load. This leakage current creates a dc offset voltage at the input to the amplifier that reduces useful headroom, especially in high-gain applications. For this reason a low-leakage tantalum or ceramic capacitor is the best choice. When polarized capacitors are used, the positive side of the capacitor should face the amplifier input in most applications as the dc level there is held at 2.5 V, which is likely higher than the source dc level. Note that it is important to confirm the capacitor polarity in the application.

POWER SUPPLY DECOUPLING

The TPA3001D1 is a high-performance CMOS audio amplifier that requires adequate power-supply decoupling to ensure the output total harmonic distortion (THD) is as low as possible. Power-supply decoupling also prevents oscillations for long lead lengths between the amplifier and the speaker. The optimum decoupling is achieved by using two capacitors of different types that target different types of noise on the power supply leads. For higher-frequency transients, spikes, or digital hash on the line, a good low equivalent-series-resistance (ESR) ceramic capacitor, typically 1 μF , placed as close as possible to the device V_{CC} lead works best. For filtering lower-frequency noise signals, a larger aluminum electrolytic capacitor of 10 μF or greater placed near the audio power amplifier is recommended.

BSN AND BSP CAPACITORS

The full H-bridge output stage uses only NMOS transistors. It therefore requires bootstrap capacitors for the high side of each output to turn on correctly. A 0.22- μF ceramic capacitor, rated for at least 25 V, must be connected from each output to its corresponding bootstrap input. Specifically, one 0.22- μF capacitor must be connected from OUTP to BSP, and one 0.22- μF capacitor must be connected from OUTN to BSN. (See [Figure 30](#).)

BSN AND BSP RESISTORS

To limit the current when charging the bootstrap capacitors, a resistor with a value of approximately 50 Ω ($\pm 10\%$ maximum) must be placed in series with each bootstrap capacitor. The current is limited to less than 500 μA .

VCLAMP CAPACITOR

To ensure that the maximum gate-to-source voltage for the NMOS output transistors is not exceeded, an internal regulator clamps the gate voltage. A 1- μF capacitor must be connected from VCLAMP (pin 7) to ground and must be rated for at least 25 V. The voltage at VCLAMP (pin 7) varies with V_{CC} and may not be used for powering any other circuitry.

MIDRAIL BYPASS CAPACITOR

The midrail bypass capacitor (C_{11} of [Figure 30](#)) is the most critical capacitor and serves several important functions. During start-up or recovery from shutdown mode, C_{BYPASS} determines the rate at which the amplifier starts up. The second function is to reduce noise produced by the power supply caused by coupling into the output drive signal. This noise is from the midrail generation circuit internal to the amplifier, which appears as degraded PSRR and THD+N.

For the bypass capacitor (C_{11}), a ceramic or tantalum low-ESR capacitor of 0.47 μF to 1 μF is recommended for the best THD noise, and depop performance. The bypass capacitor **must** have a value greater than the input capacitors for optimum depop performance.

VREF DECOUPLING CAPACITOR

The VREF terminal (pin 23) is the output of an internally-generated 5-V supply, used for the oscillator and gain-setting logic. It requires a 0.1- μF to 1- μF capacitor to ground to keep the regulator stable. The regulator may not be used to power any additional circuitry.

DIFFERENTIAL INPUT

The differential input stage of the amplifier cancels any noise that appears on both input lines of the channel. To use the TPA3001D1 EVM with a differential source, connect the positive lead of the audio source to the INP input and the negative lead from the audio source to the INN input. To use the TPA3001D1 with a single-ended source, ac ground the INN input through a capacitor and apply the audio signal to the INP input. In a single-ended input application, the INN input should be ac-grounded at the audio source instead of at the device input for best noise performance.

SWITCHING FREQUENCY

The switching frequency is determined using the values of the components connected to ROSC (pin 20) and COSC (pin 21) and may be calculated with [Equation 8](#):

$$f_s = \frac{6.6}{ROSC \text{ COSC}} \quad (8)$$

The frequency may be varied from 225 kHz to 275 kHz by adjusting the values chosen for ROSC and COSC.

SHUTDOWN OPERATION

The TPA3001D1 employs a shutdown mode of operation designed to reduce supply current (I_{CC}) to the absolute minimum level during periods of nonuse for battery-power conservation. The **SHUTDOWN** input terminal should be held high during normal operation when the amplifier is in use. Pulling **SHUTDOWN** low causes the outputs to mute and the amplifier to enter a low-current state, $I_{CC(SD)} = 1 \mu\text{A}$. **SHUTDOWN** should never be left unconnected, because amplifier operation would be unpredictable.

Ideally, the device should be held in shutdown when the system powers up and brought out of shutdown once any digital circuitry has settled. However, if **SHUTDOWN** is to be left unused, the terminal may be connected directly to V_{CC} .

USING LOW-ESR CAPACITORS

Low-ESR capacitors are recommended throughout this application section. A real (as opposed to ideal) capacitor can be modeled simply as a resistor in series with an ideal capacitor. The voltage drop across this resistor minimizes the beneficial effects of the capacitor in the circuit. The lower the equivalent value of this resistance the more the real capacitor behaves like an ideal capacitor.

START-UP TIME

The start-up time can be calculated with [Equation 9](#):

$$t_{\text{startup}} = 8.2 \text{ ms} + 2 \times 100 \text{ k}\Omega \times C11 \quad (9)$$

where C11 is the value of the bypass capacitor as shown in [Figure 30](#).

PRINTED-CIRCUIT BOARD (PCB) LAYOUT

Because the TPA3001D1 is a class-D amplifier that switches at a high frequency, the layout of the printed-circuit board (PCB) should be optimized according to the following guidelines for the best possible performance.

- Decoupling capacitors—As shown in the [Typical Application Circuit](#), the high-frequency 0.1- μ F decoupling capacitors should be placed as close to the PV_{CC} (pin 9 and pin 16) and V_{CC} (pin 24) terminals as possible. The BYPASS (pin 22) capacitor, VREF (pin 23) capacitor, and VCLAMP (pin 7) capacitor should also be placed as close to the device as possible. The large (10 μ F or greater) bulk power-supply decoupling capacitor should be placed near the TPA3001D1.
- Grounding—The V_{CC} (pin 24) decoupling capacitor, VREF (pin 23) capacitor, BYPASS (pin 22) capacitor, COSC (pin 21) capacitor, and ROSC (pin 20) resistor should each be grounded to analog ground (AGND, pin 18 and pin 19). The PV_{CC} (pin 9 and pin 16) decoupling capacitors should each be grounded to power ground (PGND, pin 12 and pin 13). Analog ground and power ground may be connected at the thermal pad, which should be used as a central ground connection or star ground for the TPA3001D1.
- Output filter—The ferrite filter ([Figure 34](#)) should be placed as close to the output terminals (pins 10, 11, 14, and 15) as possible for the best EMI performance. The LC filter ([Figure 35](#) and [Figure 36](#)) should be placed close to the ferrite filter. The capacitors used in both the ferrite and LC filters should be grounded to power ground.
- Thermal pad—The thermal pad must be soldered to the PCB for proper thermal performance and optimal reliability. The dimensions of the thermal pad thermal land should be 1,6 mm by 6 mm (63 mils by 236.2 mils). Two rows of solid vias (four vias per row, 0,3302 mm or 13 mils diameter) should be equally spaced underneath the thermal land. The vias should connect to a solid copper plane, either on an internal layer or on the bottom layer of the PCB. The vias must be solid vias, not thermal-relief or webbed vias. For additional information, see the *PowerPAD Thermally Enhanced Package* application report ([SLMA002](#)).

For an example layout, see the *TPA3001D1EVM 20-W Mono Class-D Audio Power Amplifier* user's guide ([SLOU156](#)).

PACKAGING INFORMATION

Orderable Device	Status (1)	Package Type	Package Drawing	Pins	Package Qty	Eco Plan (2)	Lead/Ball Finish	MSL Peak Temp (3)	Op Temp (°C)	Top-Side Markings (4)	Samples
TPA3001D1PWP	ACTIVE	HTSSOP	PWP	24	60	Green (RoHS & no Sb/Br)	CU NIPDAU	Level-2-260C-1 YEAR	-40 to 85	TPA3001D1	Samples
TPA3001D1PWPG4	ACTIVE	HTSSOP	PWP	24	60	Green (RoHS & no Sb/Br)	CU NIPDAU	Level-2-260C-1 YEAR	-40 to 85	TPA3001D1	Samples
TPA3001D1PWPR	ACTIVE	HTSSOP	PWP	24	2000	Green (RoHS & no Sb/Br)	CU NIPDAU	Level-2-260C-1 YEAR	-40 to 85	TPA3001D1	Samples
TPA3001D1PWPRG4	ACTIVE	HTSSOP	PWP	24	2000	Green (RoHS & no Sb/Br)	CU NIPDAU	Level-2-260C-1 YEAR	-40 to 85	TPA3001D1	Samples

(1) The marketing status values are defined as follows:

ACTIVE: Product device recommended for new designs.

LIFEBUY: TI has announced that the device will be discontinued, and a lifetime-buy period is in effect.

NRND: Not recommended for new designs. Device is in production to support existing customers, but TI does not recommend using this part in a new design.

PREVIEW: Device has been announced but is not in production. Samples may or may not be available.

OBSELETE: TI has discontinued the production of the device.

(2) Eco Plan - The planned eco-friendly classification: Pb-Free (RoHS), Pb-Free (RoHS Exempt), or Green (RoHS & no Sb/Br) - please check <http://www.ti.com/productcontent> for the latest availability information and additional product content details.

TBD: The Pb-Free/Green conversion plan has not been defined.

Pb-Free (RoHS): TI's terms "Lead-Free" or "Pb-Free" mean semiconductor products that are compatible with the current RoHS requirements for all 6 substances, including the requirement that lead not exceed 0.1% by weight in homogeneous materials. Where designed to be soldered at high temperatures, TI Pb-Free products are suitable for use in specified lead-free processes.

Pb-Free (RoHS Exempt): This component has a RoHS exemption for either 1) lead-based flip-chip solder bumps used between the die and package, or 2) lead-based die adhesive used between the die and leadframe. The component is otherwise considered Pb-Free (RoHS compatible) as defined above.

Green (RoHS & no Sb/Br): TI defines "Green" to mean Pb-Free (RoHS compatible), and free of Bromine (Br) and Antimony (Sb) based flame retardants (Br or Sb do not exceed 0.1% by weight in homogeneous material)

(3) MSL, Peak Temp. -- The Moisture Sensitivity Level rating according to the JEDEC industry standard classifications, and peak solder temperature.

(4) Multiple Top-Side Markings will be inside parentheses. Only one Top-Side Marking contained in parentheses and separated by a "~" will appear on a device. If a line is indented then it is a continuation of the previous line and the two combined represent the entire Top-Side Marking for that device.

Important Information and Disclaimer: The information provided on this page represents TI's knowledge and belief as of the date that it is provided. TI bases its knowledge and belief on information provided by third parties, and makes no representation or warranty as to the accuracy of such information. Efforts are underway to better integrate information from third parties. TI has taken and continues to take reasonable steps to provide representative and accurate information but may not have conducted destructive testing or chemical analysis on incoming materials and chemicals. TI and TI suppliers consider certain information to be proprietary, and thus CAS numbers and other limited information may not be available for release.

In no event shall TI's liability arising out of such information exceed the total purchase price of the TI part(s) at issue in this document sold by TI to Customer on an annual basis.

TAPE AND REEL INFORMATION
REEL DIMENSIONS

TAPE DIMENSIONS

A0	Dimension designed to accommodate the component width
B0	Dimension designed to accommodate the component length
K0	Dimension designed to accommodate the component thickness
W	Overall width of the carrier tape
P1	Pitch between successive cavity centers

TAPE AND REEL INFORMATION

*All dimensions are nominal

Device	Package Type	Package Drawing	Pins	SPQ	Reel Diameter (mm)	Reel Width W1 (mm)	A0 (mm)	B0 (mm)	K0 (mm)	P1 (mm)	W (mm)	Pin1 Quadrant
TPA3001D1PWPR	HTSSOP	PWP	24	2000	330.0	16.4	6.95	8.3	1.6	8.0	16.0	Q1

TAPE AND REEL BOX DIMENSIONS



*All dimensions are nominal

Device	Package Type	Package Drawing	Pins	SPQ	Length (mm)	Width (mm)	Height (mm)
TPA3001D1PWPR	HTSSOP	PWP	24	2000	367.0	367.0	38.0

MECHANICAL DATA

PWP (R-PDSO-G24)

PowerPAD™ PLASTIC SMALL OUTLINE

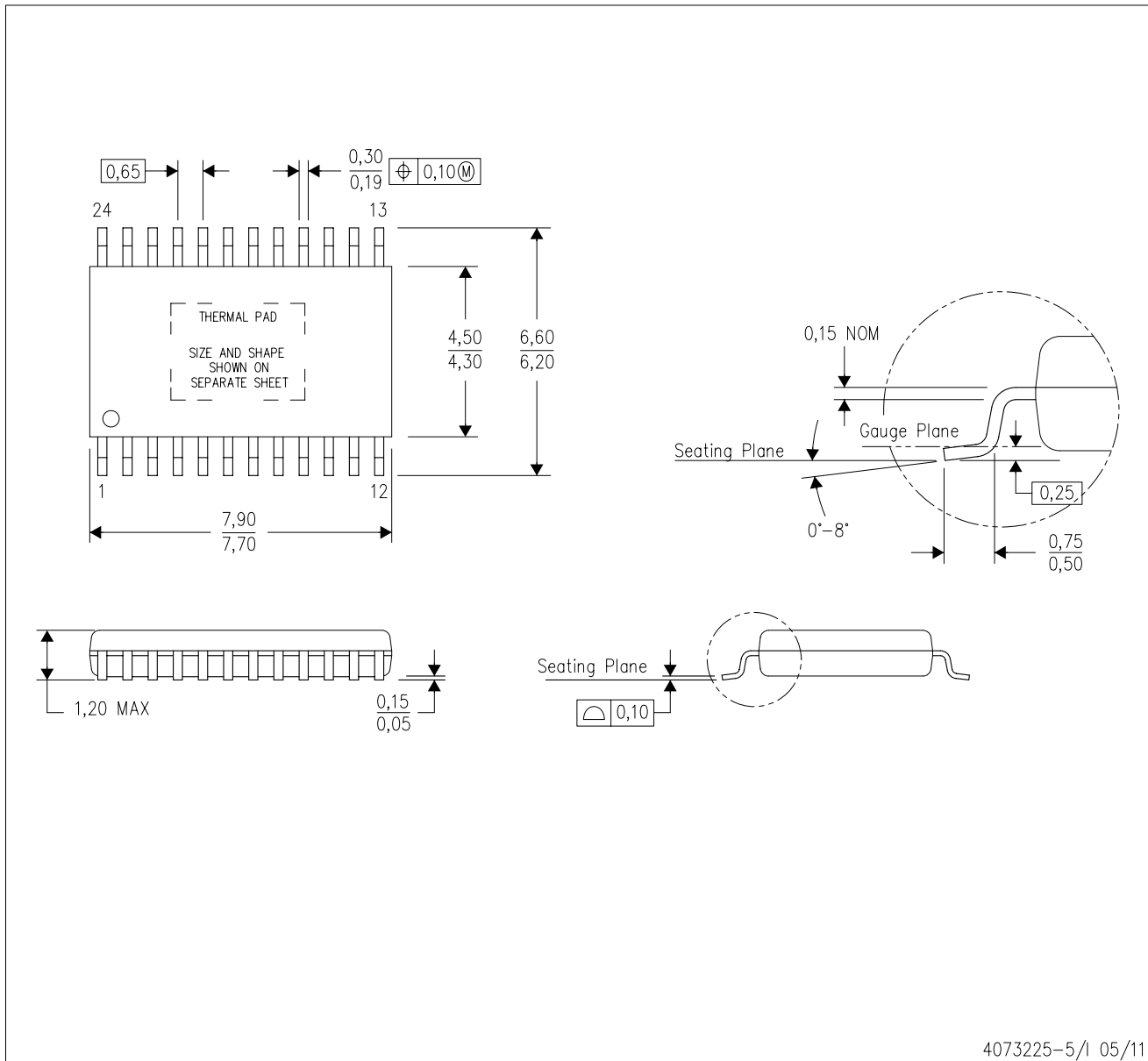

4073225-5/1 05/11

- NOTES:
- All linear dimensions are in millimeters.
 - This drawing is subject to change without notice.
 - Body dimensions do not include mold flash or protrusions. Mold flash and protrusion shall not exceed 0.15 per side.
 - This package is designed to be soldered to a thermal pad on the board. Refer to Technical Brief, PowerPad Thermally Enhanced Package, Texas Instruments Literature No. SLMA002 for information regarding recommended board layout. This document is available at www.ti.com <<http://www.ti.com>>.
 - See the additional figure in the Product Data Sheet for details regarding the exposed thermal pad features and dimensions.
 - Falls within JEDEC MO-153

PowerPAD is a trademark of Texas Instruments.

THERMAL PAD MECHANICAL DATA

PWP (R-PDSO-G24) PowerPAD™ SMALL PLASTIC OUTLINE

THERMAL INFORMATION

This PowerPAD™ package incorporates an exposed thermal pad that is designed to be attached to a printed circuit board (PCB). The thermal pad must be soldered directly to the PCB. After soldering, the PCB can be used as a heatsink. In addition, through the use of thermal vias, the thermal pad can be attached directly to the appropriate copper plane shown in the electrical schematic for the device, or alternatively, can be attached to a special heatsink structure designed into the PCB. This design optimizes the heat transfer from the integrated circuit (IC).

For additional information on the PowerPAD package and how to take advantage of its heat dissipating abilities, refer to Technical Brief, PowerPAD Thermally Enhanced Package, Texas Instruments Literature No. SLMA002 and Application Brief, PowerPAD Made Easy, Texas Instruments Literature No. SLMA004. Both documents are available at www.ti.com.

The exposed thermal pad dimensions for this package are shown in the following illustration.

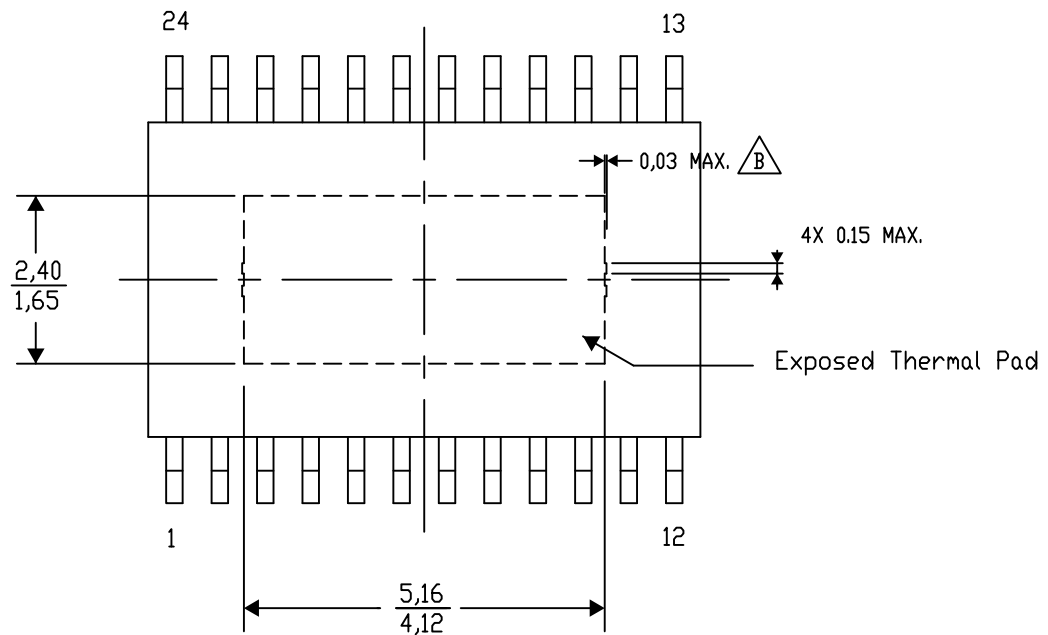

Top View

Exposed Thermal Pad Dimensions

4206332-29/AO 01/16

NOTE: A. All linear dimensions are in millimeters

B. Exposed tie strap features may not be present.

PowerPAD is a trademark of Texas Instruments

PWP (R-PDSO-G24)

PowerPAD™ PLASTIC SMALL OUTLINE

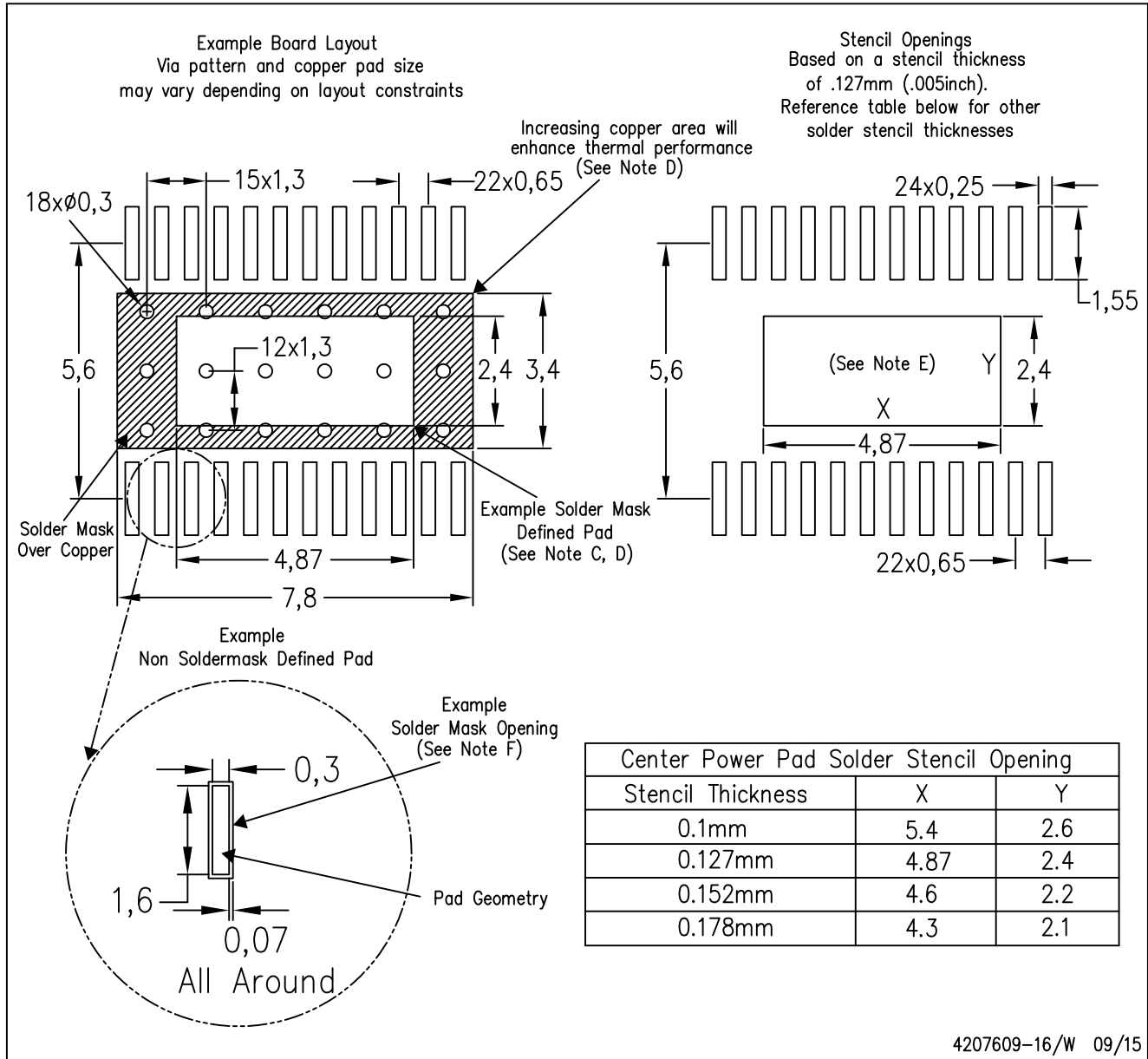

- NOTES:
- All linear dimensions are in millimeters.
 - This drawing is subject to change without notice.
 - Customers should place a note on the circuit board fabrication drawing not to alter the center solder mask defined pad.
 - This package is designed to be soldered to a thermal pad on the board. Refer to Technical Brief, PowerPAD Thermally Enhanced Package, Texas Instruments Literature No. SLMA002, SLMA004, and also the Product Data Sheets for specific thermal information, via requirements, and recommended board layout. These documents are available at www.ti.com <<http://www.ti.com>>. Publication IPC-7351 is recommended for alternate designs.
 - Laser cutting apertures with trapezoidal walls and also rounding corners will offer better paste release. Customers should contact their board assembly site for stencil design recommendations. Example stencil design based on a 50% volumetric metal load solder paste. Refer to IPC-7525 for other stencil recommendations.
 - Customers should contact their board fabrication site for solder mask tolerances between and around signal pads.

IMPORTANT NOTICE

Texas Instruments Incorporated and its subsidiaries (TI) reserve the right to make corrections, enhancements, improvements and other changes to its semiconductor products and services per JESD46, latest issue, and to discontinue any product or service per JESD48, latest issue. Buyers should obtain the latest relevant information before placing orders and should verify that such information is current and complete. All semiconductor products (also referred to herein as "components") are sold subject to TI's terms and conditions of sale supplied at the time of order acknowledgment.

TI warrants performance of its components to the specifications applicable at the time of sale, in accordance with the warranty in TI's terms and conditions of sale of semiconductor products. Testing and other quality control techniques are used to the extent TI deems necessary to support this warranty. Except where mandated by applicable law, testing of all parameters of each component is not necessarily performed.

TI assumes no liability for applications assistance or the design of Buyers' products. Buyers are responsible for their products and applications using TI components. To minimize the risks associated with Buyers' products and applications, Buyers should provide adequate design and operating safeguards.

TI does not warrant or represent that any license, either express or implied, is granted under any patent right, copyright, mask work right, or other intellectual property right relating to any combination, machine, or process in which TI components or services are used. Information published by TI regarding third-party products or services does not constitute a license to use such products or services or a warranty or endorsement thereof. Use of such information may require a license from a third party under the patents or other intellectual property of the third party, or a license from TI under the patents or other intellectual property of TI.

Reproduction of significant portions of TI information in TI data books or data sheets is permissible only if reproduction is without alteration and is accompanied by all associated warranties, conditions, limitations, and notices. TI is not responsible or liable for such altered documentation. Information of third parties may be subject to additional restrictions.

Resale of TI components or services with statements different from or beyond the parameters stated by TI for that component or service voids all express and any implied warranties for the associated TI component or service and is an unfair and deceptive business practice. TI is not responsible or liable for any such statements.

Buyer acknowledges and agrees that it is solely responsible for compliance with all legal, regulatory and safety-related requirements concerning its products, and any use of TI components in its applications, notwithstanding any applications-related information or support that may be provided by TI. Buyer represents and agrees that it has all the necessary expertise to create and implement safeguards which anticipate dangerous consequences of failures, monitor failures and their consequences, lessen the likelihood of failures that might cause harm and take appropriate remedial actions. Buyer will fully indemnify TI and its representatives against any damages arising out of the use of any TI components in safety-critical applications.

In some cases, TI components may be promoted specifically to facilitate safety-related applications. With such components, TI's goal is to help enable customers to design and create their own end-product solutions that meet applicable functional safety standards and requirements. Nonetheless, such components are subject to these terms.

No TI components are authorized for use in FDA Class III (or similar life-critical medical equipment) unless authorized officers of the parties have executed a special agreement specifically governing such use.

Only those TI components which TI has specifically designated as military grade or "enhanced plastic" are designed and intended for use in military/aerospace applications or environments. Buyer acknowledges and agrees that any military or aerospace use of TI components which have **not** been so designated is solely at the Buyer's risk, and that Buyer is solely responsible for compliance with all legal and regulatory requirements in connection with such use.

TI has specifically designated certain components as meeting ISO/TS16949 requirements, mainly for automotive use. In any case of use of non-designated products, TI will not be responsible for any failure to meet ISO/TS16949.

Products

Audio	www.ti.com/audio
Amplifiers	amplifier.ti.com
Data Converters	dataconverter.ti.com
DLP® Products	www.dlp.com
DSP	dsp.ti.com
Clocks and Timers	www.ti.com/clocks
Interface	interface.ti.com
Logic	logic.ti.com
Power Mgmt	power.ti.com
Microcontrollers	microcontroller.ti.com
RFID	www.ti-rfid.com
OMAP Applications Processors	www.ti.com/omap
Wireless Connectivity	www.ti.com/wirelessconnectivity

Applications

Automotive and Transportation	www.ti.com/automotive
Communications and Telecom	www.ti.com/communications
Computers and Peripherals	www.ti.com/computers
Consumer Electronics	www.ti.com/consumer-apps
Energy and Lighting	www.ti.com/energy
Industrial	www.ti.com/industrial
Medical	www.ti.com/medical
Security	www.ti.com/security
Space, Avionics and Defense	www.ti.com/space-avionics-defense
Video and Imaging	www.ti.com/video

TI E2E Community

e2e.ti.com