



MBR1090CT thru MBR10100CT

New Product

Vishay Semiconductors
formerly General Semiconductor

Dual High-Voltage Schottky Rectifiers

Reverse Voltage 90 to 100V
Forward Current 10A

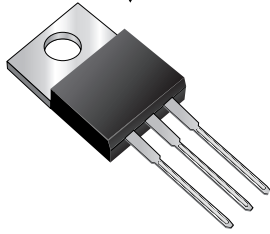

TO-220AB

Features

- Plastic package has Underwriters Laboratory Flammability Classification 94V-0
- Dual rectifier construction, positive center tap
- Metal silicon junction, majority carrier conduction
- Low power loss, high efficiency
- Guardring for overvoltage protection
- For use in low voltage, high frequency inverters, free wheeling, and polarity protection applications

Mechanical Data

Case: JEDEC TO-220AB molded plastic body over passivated chips

Terminals: Plated leads, solderable per MIL-STD-750, Method 2026

High temperature soldering guaranteed: 250°C/10 seconds, 0.25" (6.35mm) from case

Polarity: As marked

Mounting Position: Any

Mounting Torque: 10 in-lbs maximum

Weight: 0.08 oz., 2.24 g

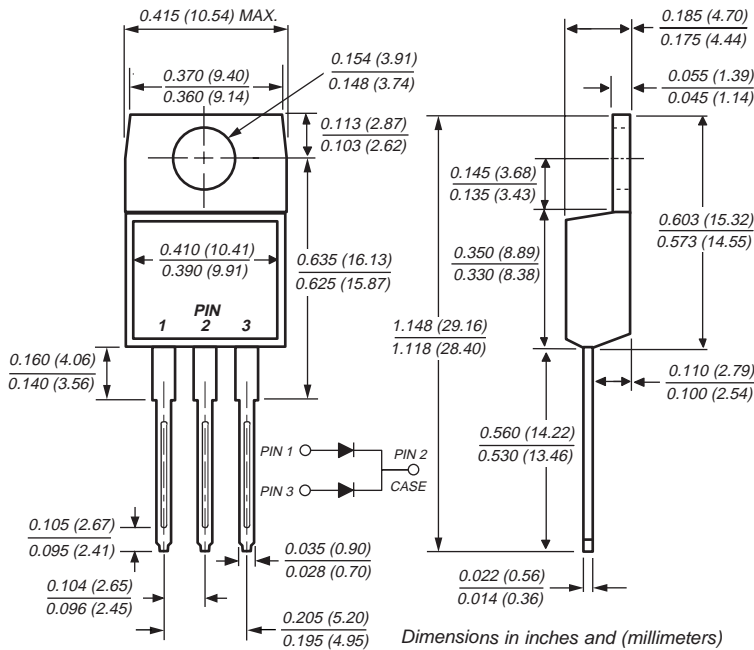

Maximum Ratings and Thermal Characteristics (T_C = 25°C unless otherwise noted)

Parameter	Symbol	MBR1090CT	MBR10100CT	Unit
Maximum repetitive peak reverse voltage	V _{RRM}	90	100	V
Working peak reverse voltage	V _{RWM}	90	100	V
Maximum DC blocking voltage	V _{DC}	90	100	V
Maximum average forward rectified current <i>Total device at T_C = 105°C</i> <i>Per leg</i>	I _{F(AV)}	10	5	A
Peak forward surge current 8.3ms single half sine-wave superimposed on rated load (JEDEC Method) per leg	I _{FSM}	120		A
Peak repetitive reverse current per leg at t _p = 2μs, 1KHZ	I _{RRM}	0.5		A
Voltage rate of change (rated V _R)	dv/dt	10,000		V/μs
Typical thermal resistance per leg	R _{θJC}	4.4		°C/W
Operating junction and storage temperature range	T _J , T _{STG}	-65 to +150		°C

Electrical Characteristics (T_C = 25°C unless otherwise noted)

Parameter	Symbol	MBR1090CT	MBR10100CT	Unit
Maximum instantaneous forward voltage per leg ⁽⁴⁾ at I _F = 5.0A, T _C = 125°C at I _F = 5.0A, T _C = 25°C	V _F	0.75	0.85	V
Maximum reverse current per leg at working peak reverse voltage ⁽⁴⁾ T _J = 25°C T _J = 100°C	I _R	100	6.0	μA mA

- Notes:** (1) Clip mounting (on case), where lead does not overlap heatsink with 0.110" offset
(2) Clip mounting (on case), where leads do overlap heatsink
(3) Screw mounting with 4-40 screw, where washer diameter is ≤ 4.9 mm (0.19")
(4) Pulse test: 300μs pulse width, 1% duty cycle

Vishay Semiconductors
formerly General Semiconductor

Ratings and Characteristic Curves ($T_A = 25^\circ\text{C}$ unless otherwise noted)

Fig. 1 – Forward Current Derating Curve

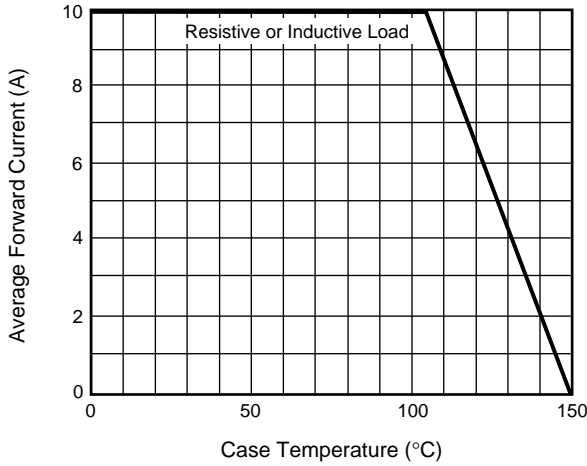

Fig. 2 – Maximum Non-Repetitive Peak Forward Surge Current Per Leg

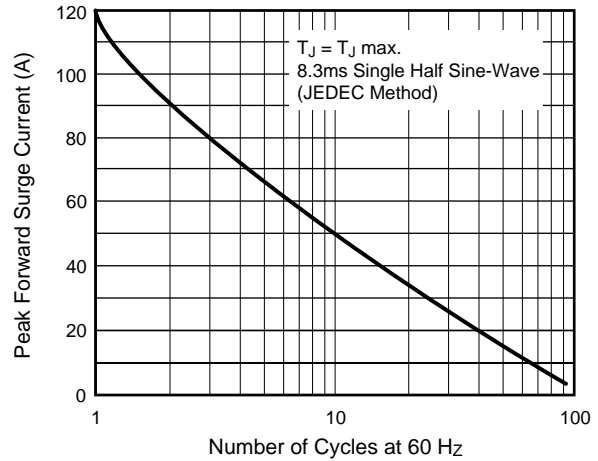

Fig. 3 – Typical Instantaneous Forward Characteristics Per Leg

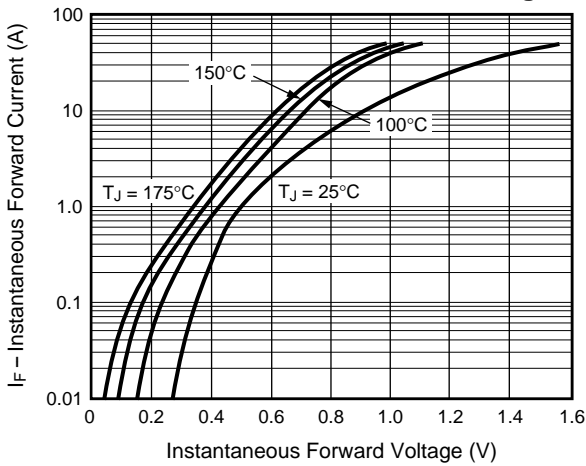

Fig. 4 – Typical Reverse Characteristics Per Leg

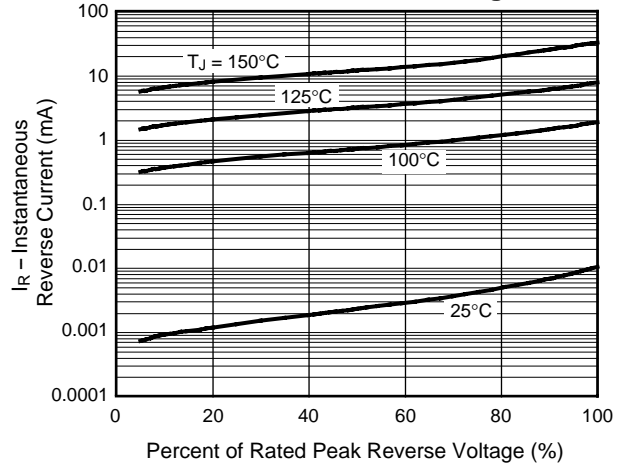

Fig. 5 – Typical Transient Thermal Impedance Per Leg

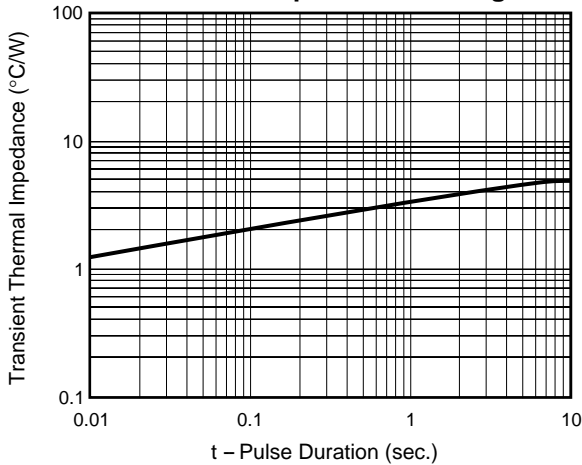
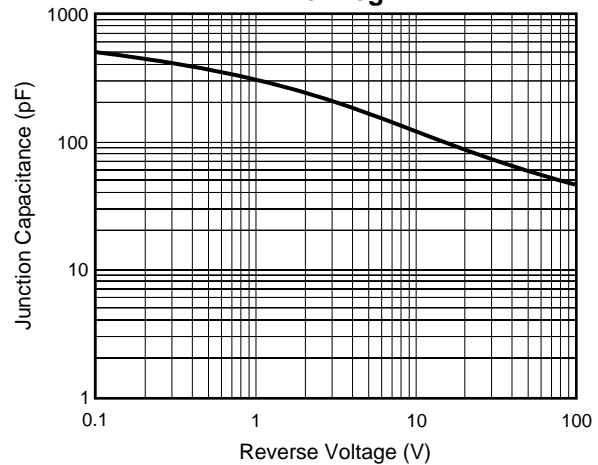

Fig. 6 – Typical Junction Capacitance Per Leg



This datasheet has been download from:

www.datasheetcatalog.com

Datasheets for electronics components.