

**POWER  SONIC**



**Nickel Cadmium and Nickel-Metal Hydride  
Rechargeable Batteries and Chargers**



**We've Got The Power.™**

# Table of Contents



Battery Features and Construction .....	1
Batteries – Standard Range .....	2
NiCd Charging and Discharging Characteristics .....	3-4
NiMH Charging and Discharging Characteristics.....	4-5
NiCd and NiMH Charging Method .....	6
Cell Assemblies .....	7
Important Do's and Don'ts.....	8-10
Recycling.....	10
Differences Between NiCd and NiMH Batteries.....	10
NiCd and NiMH Cell Profiles.....	11-12
PSN-Series Charger Specifications .....	13

Button Cell Construction

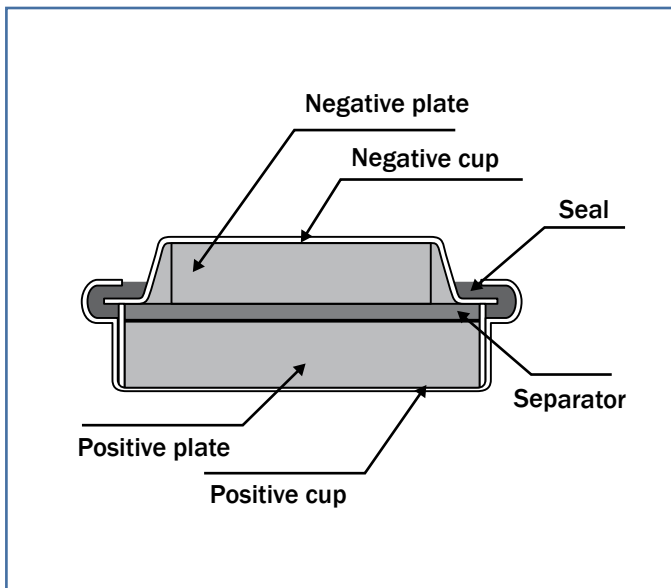

Cylindrical Cell Construction

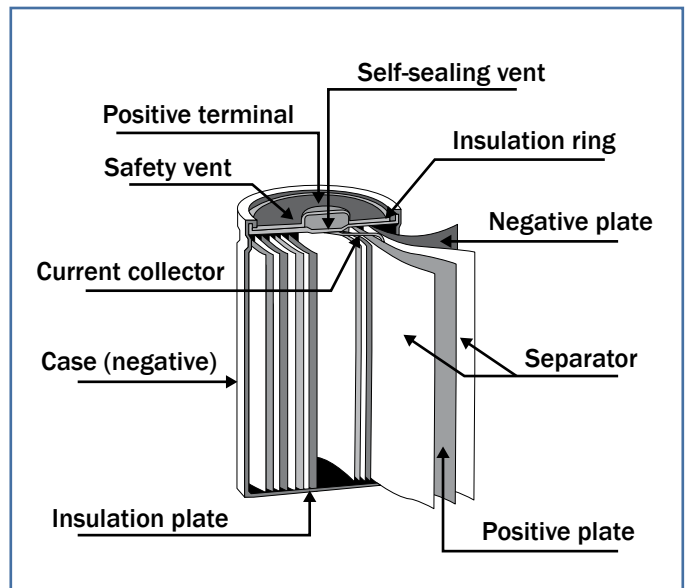



## Features - Nickel Cadmium & Nickel-Metal Hydride Batteries

### Large Array of Sizes and Types

Power-Sonic offers a broad range of cell sizes and types to meet a wide range of configurations and applications. Capacities range from 110 – 8000 mA. The batteries listed are our standard range. Other sizes and/or terminal configurations are available, subject to minimum order quantities and delivery times.

### Exceptional Performance

State of the art design and meticulously controlled manufacturing ensure the highest performance levels in terms of energy density and voltage stability.

### Rugged, Durable and Safe

The cylindrical steel case coupled with state-of-the-art manufacturing result in extremely impact and vibration resistant batteries.

### Long Shelf Life

The cells have a long storage life with few limiting conditions. Ideally they should be stored in a discharged state.

### Uniformity of Cells

This is achieved through a quality control system which electronically screens cells as to capacity and impedance. This virtually eliminates the need for cell matching and enhances long term performance in cell assemblies.

### Excellent Discharge Characteristics

Power-Sonic batteries have low internal resistance and high flat voltage characteristics during high current discharge. This allows the batteries to be used in a wide range of applications.

### Long Service Life

500-1000 charge/discharge cycles can be obtained depending on the average depth of discharge. In standby (trickle charge) mode up to five years of trouble free operation can be expected when the battery is operated at room temperature.

### Self Sealing Safety Vent

All cells are equipped with a safety valve that will vent to release any excess gases generated in an overcharge, short circuit or reverse charge situation. The valve automatically resets when the cell returns to normal operating conditions.

### Wide Temperature Range

An operating discharge temperature range of -4 °F to 140 °F (-20 °C to 60 °C) for regular cells and -4 °F to 158 °F (-20 °C to 70 °C) for high temperature cells provides design flexibility for a wide spectrum of environmental extremes. The allowable temperature range for charging is 32 °F to 122 °F (0 °C to 50 °C).

## Typical Applications

- Power tools
- Cell phones
- Hand tools
- Laptop computers
- Walkie Talkies
- Radio controlled models & toys
- Flashlights
- PDA's
- GPS systems
- Emergency lighting
- Calculators
- Cordless phones
- Portable recorders
- Photographic & video equipment
- Portable printers
- Garden lights
- Cordless mouse
- Cordless keyboard



## Specifications - Nickel Cadmium Batteries (NiCd)

### Nickel Cadmium - Standard Cells

Model Number	Cell Size	Top Type	Voltage (V)	Capacity mA	Standard Charge		Quick Charge		Diameter		Height		Weight (grams)
					mA	hrs.	mA	hrs.	in.	mm	in.	mm	
PS-AAA	AAA	Button	1.2	300	30	14	300	1.2*	0.40	10.1	1.72	43.6	10
PS-2/3AA	2/3AA	Flat	1.2	300	30	14	300	1.2*	0.56	14.1	1.10	28.0	12
PS-AA	AA	Flat	1.2	600	60	15	600	1.2*	0.56	14.1	1.89	48.0	21
PS-AAL	AA	Button	1.2	600	60	14	600	1.2*	0.56	14.1	1.95	49.5	18
PS-AAX	AA	Flat	1.2	700	70	15	700	1.2*	0.56	14.1	1.89	48.0	22
PS-850AA	AA	Flat	1.2	850	85	16	425	2.4*	0.56	14.1	1.89	48.0	23
PS-850AAL	AA	Button	1.2	850	85	16	425	2.4*	0.56	14.1	1.95	49.5	23
PS-2/3A	2/3A	Flat	1.2	600	60	14	600	1.2*	0.64	16.3	1.08	27.4	15.5
PS-4/5A	4/5A	Flat	1.2	1000	100	15	1000	1.2*	0.66	16.8	1.66	42.1	30
PS-A	A	Flat	1.2	1400	140	15	700	2.4*	0.66	16.8	1.93	49.0	33
PS-SC	SC	Flat	1.2	1500	150	15	1500	1.2*	0.87	22.1	1.65	42.0	44
PS-C	C	Flat	1.2	2000	200	15	2000	1.2*	1.00	25.3	1.93	49.0	68
PS-CX	C	Flat	1.2	2500	250	14	1250	2.4*	1.00	25.3	1.93	49.0	64
PS-1/2D	1/2D	Flat	1.2	2400	250	14	1250	2.4*	1.26	32.1	1.38	35.0	71
PS-D	D	Flat	1.2	4000	400	15	1200	4.0*	1.26	32.1	2.32	59.0	123
PS-DL	D	Button	1.2	4000	400	14	2000	2.4*	1.26	32.1	2.38	60.5	120
PS-DX	D	Flat	1.2	5000	500	15	2500	2.4*	1.27	32.2	2.32	59.0	138
PS-F	F	Flat	1.2	7000	700	14	3500	2.4*	1.27	32.2	3.50	89.0	179

\* Quick or rapid charge only with negative delta voltage cutoff. Refer to individual specification sheets for details

### Nickel Cadmium - High Temperature Cells (H-Type)

PS-1/3AAH	1/3AA	Flat	1.2	110	11	16	n/a		0.56	14.1	0.67	17.0	7
PS-AAH	AA	Flat	1.2	700	70	14	n/a		0.56	14.1	1.89	48.0	22
PS-SCH	SC	Flat	1.2	1500	150	15	n/a		0.87	22.1	1.65	42.0	41
PS-CH	C	Flat	1.2	2200	220	16	n/a		1.00	25.3	1.93	49.0	68
PS-DH	D	Flat	1.2	4000	400	14	n/a		1.27	32.2	2.32	59.0	138

### Nickel Cadmium - High Capacity Rapid Charge Cells

PS-AAXF	AA	Flat	1.2	700	70	15	700	1.2*	0.56	14.1	1.93	49.0	22
PS-SCXF	SC	Flat	1.2	1800	180	15	1800	1.2*	0.87	22.1	1.65	42.0	46
PS-CXF	C	Flat	1.2	2500	250	15	1150	2.4*	1.00	25.3	1.93	49.0	68
PS-DF	D	Flat	1.2	4500	450	15	2100	2.4*	1.27	32.2	2.32	59.0	135
PS-DXF	D	Flat	1.2	5000	500	16	2300	2.4*	1.27	32.2	2.32	59.0	138

\* Quick or rapid charge only with negative delta voltage cutoff. Refer to individual specification sheets for details

### Nickel Cadmium - PCB (Printed Circuit Board Mount) Memory Save Cells

PCBM-2.4	1/3AA/3	P.C. PINS	2.4	110	4	48		0.57	14.5	1.35	34.5	15
PCBM-3.6	1/3AA/3	P.C. PINS	3.6	110	11	16		0.57	14.5	2.05	52	21

## Specifications - Nickel-Metal Hydride Batteries (NiMH)

### Nickel-Metal Hydride - Cylindrical Cells

NH-600AAA	AAA	Flat	1.2	600	60	14	600	1.2*	0.40	10.1	1.72	43.6	12
NH-1250AA	AA	Flat	1.2	1250	125	16	1250	1.2*	0.56	14.1	1.89	48.0	23
NH-1250AAL	AA	Button	1.2	1250	125	16	1250	1.2*	0.56	14.1	1.95	49.5	23
NH-1500AA	AA	Flat	1.2	1500	150	16	1500	1.2*	0.56	14.1	1.89	48.0	25
NH-1500AAL	AA	Button	1.2	1500	150	16	1500	1.2*	0.56	14.1	1.95	49.5	23
NH-2000AA	AA	Flat	1.2	2000	200	16	1000	2.4*	0.56	14.1	1.89	48.0	29
NH-1600A	4/5A	Flat	1.2	1600	160	16	800	2.4*	0.66	16.8	1.66	42.1	33
NH-2200A	4/5A	Flat	1.2	2200	220	16	1100	2.4*	0.66	16.8	1.66	42.1	38
NH-3500A	4/3A	Flat	1.2	3500	350	14	1750	2.4*	0.65	16.6	2.60	66	51
NH-3000SC	SC	Flat	1.2	3000	300	16	1500	2.4*	0.87	22.1	1.65	42.0	59
NH-7000D	D	Flat	1.2	7000	700	14	3500	2.4*	1.27	32.2	2.32	59.0	153
NH-8000D	D	Flat	1.2	8000	800	15	4000	2.4*	1.27	32.2	2.32	59.0	160

\* Quick or rapid charge only with negative delta voltage cutoff. Refer to individual specification sheets for details

### Nickel-Metal Hydride - Button Cells

NH-B80		Button	1.2	80	8	15	n/a		0.67	15.4	0.25	6.3	3.5
NH-B320		Button	1.2	320	32	15	n/a		0.98	25.0	0.30	7.6	14.5
NH-TR7	9V Size	Snap On	8.4	150	15	15	n/a		n/a		0.61	15.5	42

Other sizes and/or terminal configurations are available, subject to minimum order quantities and delivery times.

# Nickel Cadmium Batteries Charging and Discharging Characteristics

## Discharge

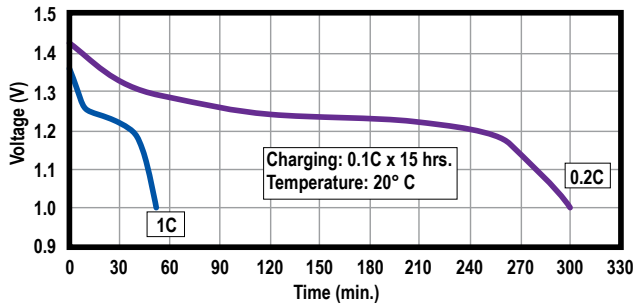

## Charging

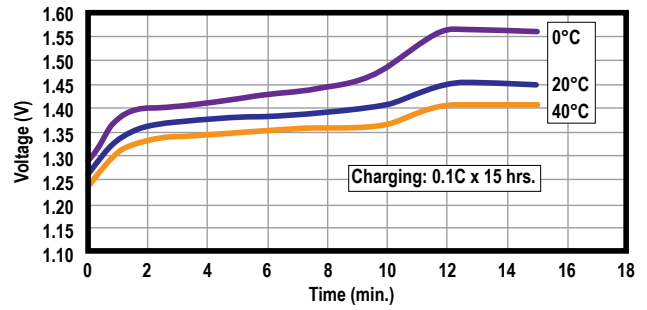

## Fast Charging

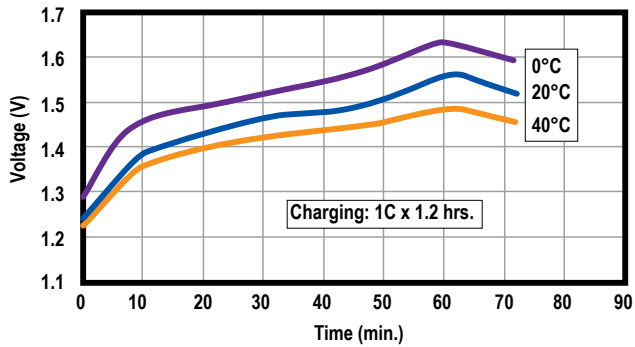

## Trickle Charge

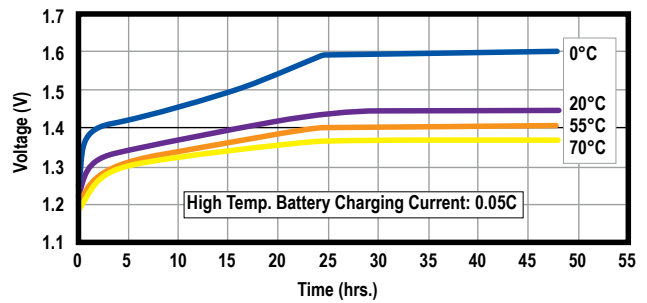

## Standard Battery Cycle Life

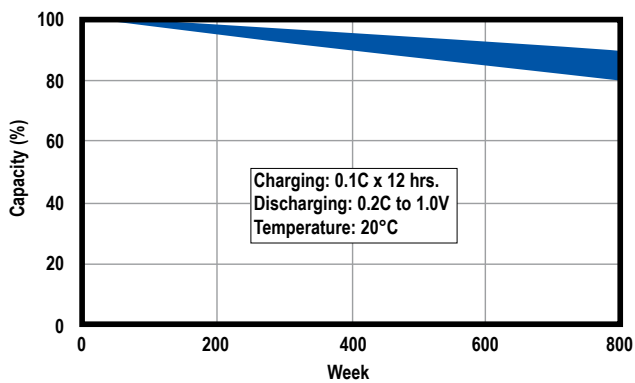

## Fast Charging Cycle Life

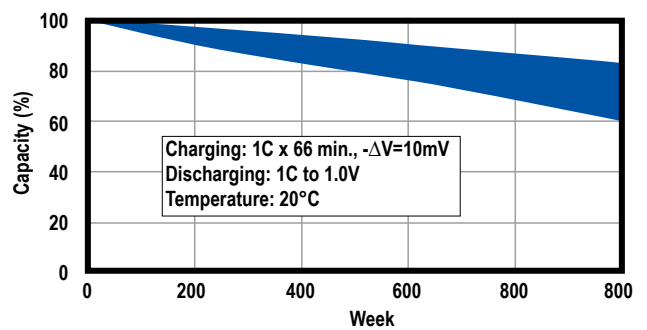

## Cycle Life Using Trickle Charging

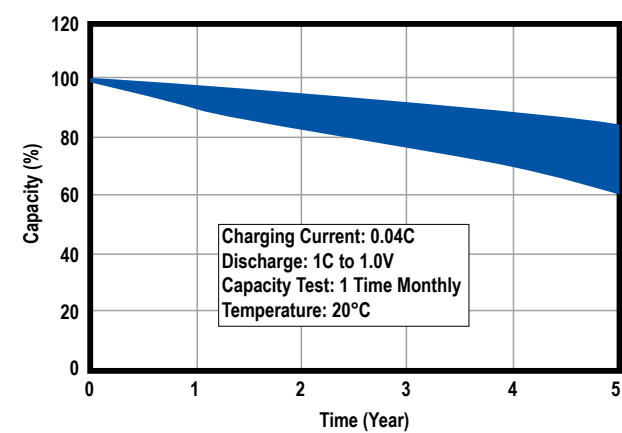

## Expected Cycle Life

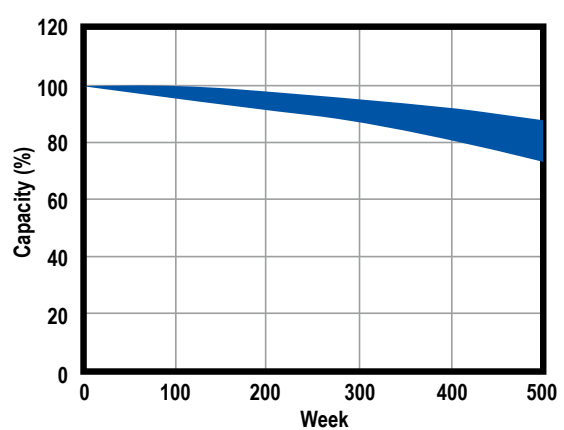

# Nickel Cadmium Batteries Charging and Discharging Characteristics

## Stand-by Battery Life

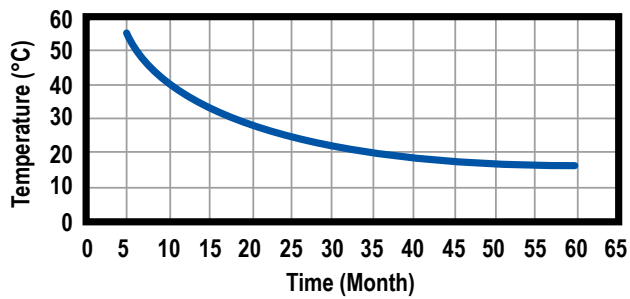

## Capacity vs Temperature

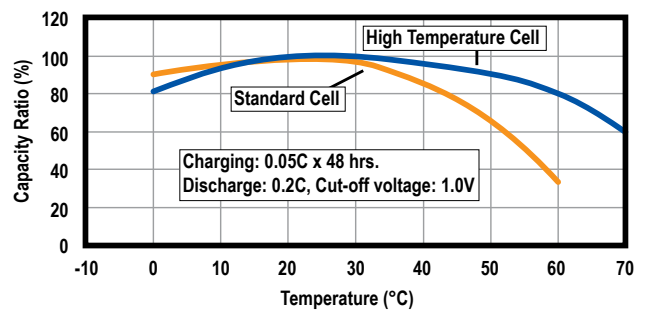

## Retained Capacity in Storage

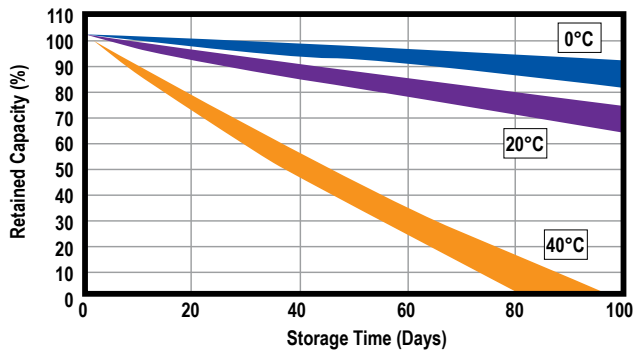

# Nickel-Metal Hydride Batteries Charging and Discharging Characteristics

## Standard Battery Charging

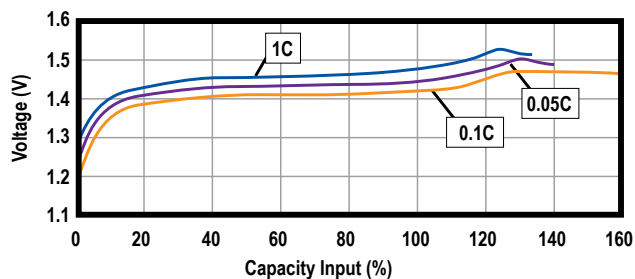

## Standard Battery Discharge Cycle Life

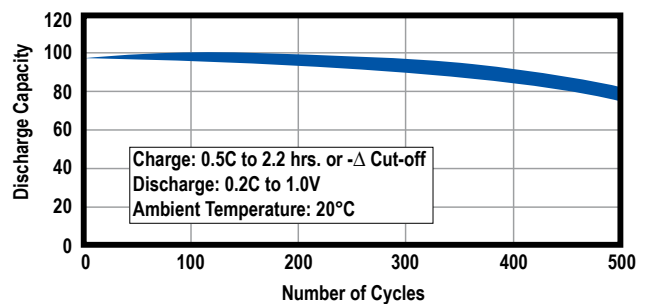

# Nickel-Metal Hydride Batteries Charging and Discharging Characteristics

## Standard Battery Discharging (0.2C/0.5C/1C)

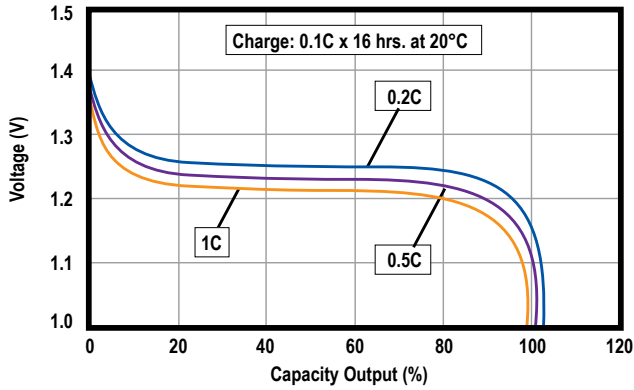

## Standard Battery Discharging (1C/2C/3C)

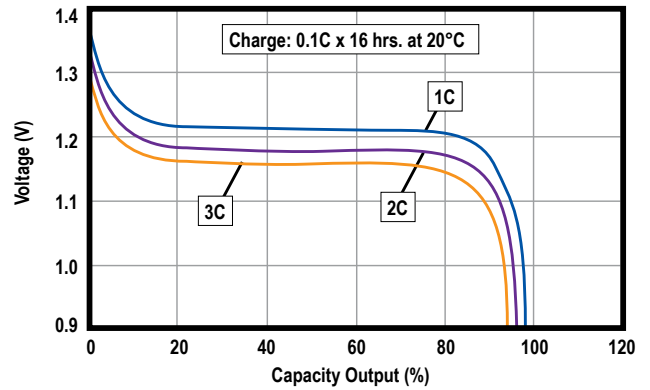

Please note the following graphs are for High Temperature and High Power batteries. These batteries do not form part of our standard range, but both types are available on request subject to minimum order quantities and delivery times. Please contact us for further details.

## High Temp. Battery Charging & Discharging

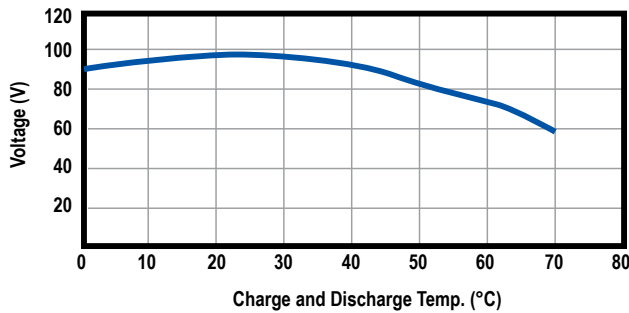

## High Power (10C Discharge) Cycle Life

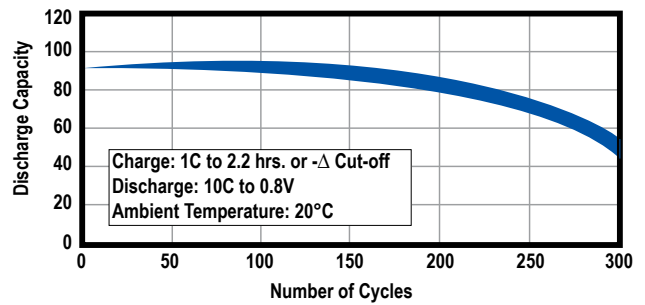

## High Temp. Battery Discharge Cycle Life

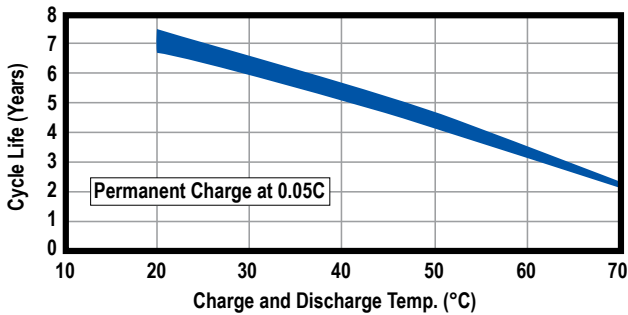

## High Power Battery Discharging (3C/5C/10C)

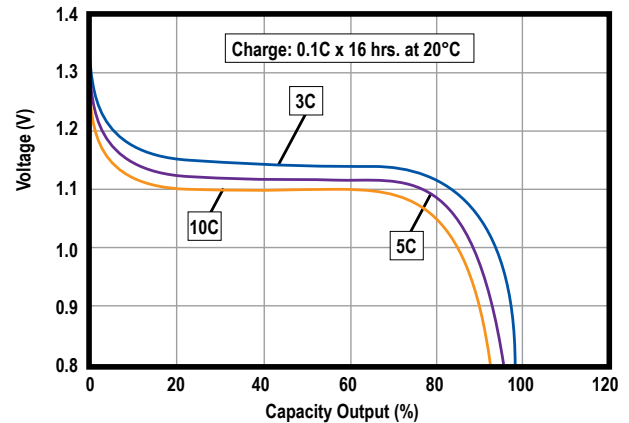

## High Temp. Battery Trickle Charge

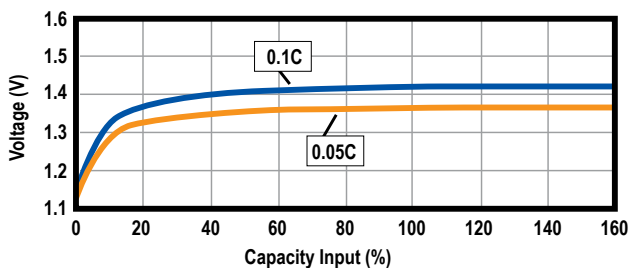

## Nickel Cadmium and Nickel-Metal Hydride Battery Charging Method

	Constant Current Slow Charge	Time Controlled Fast Charge	- $\Delta V$ Cutoff Charge	dT/dt Cutoff Charge	Trickle Charge
No. of output terminals	2	2	2	3	2
Charge time	15 hours	6 to 8 hours	1 to 2 hours	1 to 2 hours	30 hours or longer
Charge current	0.1 CmA	0.2 CmA	0.5 to 1 CmA	0.5 to 1 CmA	Frequent charge 1/30 to 1/20 CmA
Charge level at charge control	—————	Approx. 120%	Approx. 110 to 120%	Approx. 110 to 150%	—————
Features	<p>NiCd and NiMH</p> <ul style="list-style-type: none"> <li>• Cycle applications</li> <li>• Simple charge</li> <li>• Trickle charge</li> </ul>	<p>Most NiMH and NiCd</p> <ul style="list-style-type: none"> <li>• Cycle applications</li> <li>• Simple charge</li> <li>• Trickle charge</li> </ul>	<p>NiCd and NiMH</p> <ul style="list-style-type: none"> <li>• Cycle applications</li> <li>• Trickle charge</li> <li>• Reliable indication of charge state</li> </ul>	<p>NiCd and NiMH</p> <ul style="list-style-type: none"> <li>• Cycle applications</li> <li>• Trickle charge</li> <li>• Highly reliable indication of charge state</li> </ul>	<p>NiCd and NiMH</p> <ul style="list-style-type: none"> <li>• Cycle and standby applications</li> <li>• Simple charge</li> </ul>



## Nickel Cadmium and Nickel-Metal Hydride Cell Assemblies

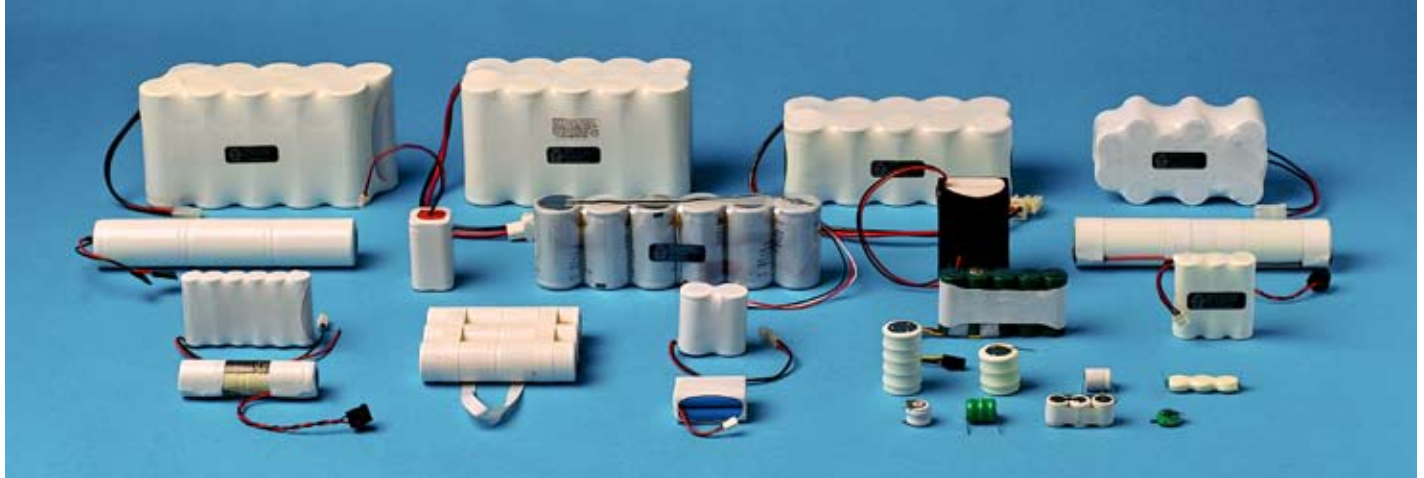

Power-Sonic NiCd & NiMH batteries are also available as cell assemblies and packs. Both cylindrical and button cells may be packaged in any linear or tubular configuration to meet electrical and dimensional requirements.

The basic building block of any nickel cadmium or nickel-metal hydride battery pack is the 1.2V cell, either button or cylindrical and they can be assembled together in a variety of ways, either in series or parallel. For example, 10 cells configured as a pack and connected in series will form a 12 volt battery.

### Linear Configurations



### Tubular Configurations

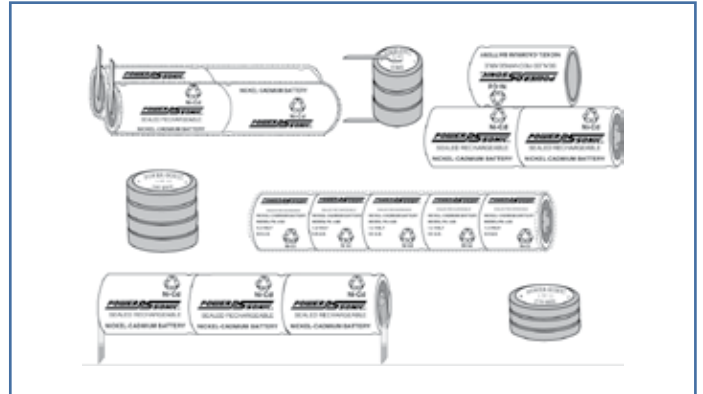

When specifying battery assemblies, the following information should be given:

- Size and type of cell
- Voltage or number of cells
- Configuration of cells: e.g., 1 x 4, 2 x 5, stick, etc.
- Operating temperatures for the battery
- Packaging method: taped or glued with hot melt; with or without shrink wrap
- Termination: button top, solder tabs (incl. direction), or wire leads with or without connectors

When ordering a replacement battery pack, please specify:

- Voltage or number of cells
- Ampere-hour capacity or cell size
- Dimensions of the pack



## Important Do's and Don'ts

Power-Sonic rechargeable batteries are designed to provide years of dependable service. Adherence to the following guidelines in system design will ensure that battery life is maximized and operation is trouble free.

### Material Safety Data Sheets (MSDS)

- It is important that you familiarize yourself with these prior to handling, installing and disposing of all batteries. If there are any questions raised from these please contact Power-Sonics' technical department.

### Handling

- Follow all precautions as described in our Material Safety Data Sheets (MSDS). This information is subject to change depending on government legislation. Visit our website: [www.power-sonic.com](http://www.power-sonic.com) for up-to-date copies.

### Installation

- Fasten batteries tightly and make provisions for shock absorption if exposure to shock or vibration is likely.
- When installing the battery within a piece of equipment, fix it securely at the lowest practicable point.
- Do not mix batteries with unlike capacities, different ages, dissimilar chemistries or different makes. The difference in characteristics will cause damage to the batteries.

### Charging

#### *Charging Temperature*

- Charge batteries within an ambient temperature range of 32 °F to 122 °F (0 °C to 50 °C).
- Ambient temperature during charging affects charge efficiency. Charge efficiency is best within a temperature range of 50 °F to 86 °F (10 °C to 30 °C).
- At temperature below 32 °F (0 °C), the gas absorption reaction is not efficient, causing gas pressure inside the cell to rise, which can activate the safety vent and lead to leakage of alkaline liquid and deterioration of performance.
- Charge efficiency drops at temperatures above 104 °F (40 °C). This can disrupt the charging process and lead to deterioration of performance and leakage.

#### *Reverse Charging*

- Charging with polarities reversed can cause a reversal in cell polarity, causing gas pressure inside of the cell to rise. This can activate the safety vent, lead to leakage of alkaline electrolyte, rapid deterioration of battery performance, even battery swelling and battery rupture.

#### *Overcharging*

- Avoid overcharging. Repeatedly overcharging can lead to deterioration of battery performance.

#### *Quick Charging*

- Batteries can be charged rapidly, please refer to the individual specification sheets for details.

#### *Trickle Charging*

- To apply a trickle charge use the charging methods recommended by Power-Sonic, as detailed in the individual specification sheets.

## Important Do's and Don'ts

### Discharging

#### **Discharge Temperatures**

- Discharge batteries within an ambient temperature range of: Nickel Cadmium -4 °F to 149 °F (-20 °C to 65 °C ), Nickel-Metal Hydride 14 °F to 122 °F (-10 °C to 50 °C)
- Discharge capacity will drop when the battery is discharged outside the ambient temperature range

#### **Over-Discharging**

- Over-discharging damages the batteries performance. Full discharge has been reached when the the voltage drops to 0.9V to 1.0V, see the individual specification sheets for the applicable details. When the battery has been fully discharged It should be disconnected from the equipment circuit.

#### **Storage Temperature and Humidity (short-term)**

- Store in a dry location with low humidity (Max.85%), within a temperature range of -4 °F to 113 °F (-20 °C to 45 °C)

#### **Long-term Storage**

- Store within temperature ranges between 50 °F to 86 °F (10 °C to 30 °C).
- When charging for the first time after long-term storage, deactivation of the batteries' chemicals may have led to decreased battery capacity. Restore such batteries to original performance through repeating several cycles of charging and discharging.

#### **Cycle Life**

- Significantly reduced discharge time, in spite of proper charging, means that the life of the battery has been exceeded. Also, at the end of service life, an unusual increase in internal resistance, or an internal short-circuit failure may occur.

#### **Service Life in Standby Operation**

- Normally, a battery will last 3 to 5 years if used under proper conditions. However, failure to satisfy conditions concerning charging, discharging, temperature and other factors during actual use can lead to shortened battery life.

### Assembly And Design Considerations

#### **Connecting Batteries to Products**

- Never solder a lead wire or other connecting materials directly to the battery. Doing so will damage the battery's internal safety vent, separator, and other materials.
- To connect a battery spot-weld a tab made of nickel or nickel-plated steel to the battery's terminal strip, then solder a lead wire to the tab.
- Use caution when disconnecting batteries from the equipment.

#### **Material for Terminals in Products Using the Batteries**

- Small amounts of alkaline electrolyte can leak out from the battery seal during a period of extended use or when the safety vent is activated during improper use, use a highly alkaline-resistant material for a product's contact terminals to avoid problems due to corrosion.

## Important Do's and Don'ts

### Safety Considerations When Handling Batteries

- Always familiarize yourself with the MSDS – see Material Safety Data Sheets (MSDS) above.
- Never disassemble a battery, as the electrolyte inside is strong alkaline and can damage skin and clothes.
- Never attempt to short-circuit a battery, doing so can damage the product & generate heat that can cause burns.
- Never dispose of batteries into a fire as it will cause the battery to rupture, release noxious chemicals and possibly explode.
- Never solder anything directly to a battery as this will damage the safety vent inside the cap.
- Never insert the batteries with their polarities reversed as this can cause the battery to swell or rupture.
- Never reverse charge or overcharge with high current. Doing so causes rapid gas generation and increased gas pressure, causing batteries to swell or rupture.
- Never charge batteries with a modified and/or unspecified charger as this can cause batteries to swell or rupture.
- Never place the batteries in a sealed container as gases (oxygen, hydrogen) may be given off, and there is a danger of the batteries rupturing or exploding in the presence of a source of ignition.
- Never use a battery in an appliance for which it was not intended. Differences in specifications can lead to damage to the battery or appliance.

### Recycling

- Nickel Cadmium batteries contain materials that are harmful to the environment and they should be re-cycled. Nickel-Metal Hydride batteries are more environmentally friendly, but we strongly recommend that they be re-cycled as the main derivative is nickel, which is considered semi-toxic.

To find out more about recycling, the applicable Federal and State laws and local battery recycling locations in your area we would direct you to the following sites: <http://www.call2recycle.org> – Tel: 877-723-1297, and <http://www.earth911.org>.

## Differences Between Nickel Cadmium (NiCd) And Nickel-Metal Hydride (NiMH) Batteries

### ***Nickel Cadmium***

- Nickel Cadmium batteries, are an older form of rechargeable battery. While they tend to be less expensive than newer designs, the toxic cadmium used in their construction makes them harmful to the environment. They have lower self-discharge levels than NiMH batteries

### ***Nickel-Metal Hydride***

- Nickel-Metal Hydride batteries are more expensive to produce than NiCd batteries, but offer a few advantages over the older design.

### ***Charge Levels***

- NiMH batteries are capable of storing and holding a greater charge than their predecessors. For instance, in high-drain devices like cameras they can offer up to twice the battery life.

### ***Memory***

- NiCd batteries can develop a “memory” when not fully discharged. Crystals can develop inside the battery which interferes with charge levels, reducing the effective lifespan of the cell between charges and preventing a full recharge.

### ***Cold Temperatures***

- NiCd batteries can be discharged over a wider temperature range (-4 °F to 149 °F) than NiMH batteries (14 °F to 122 °F)

### ***Service Life***

- While NiCd batteries must be carefully charged and discharged to maintain their usable lifespan, they can remain in service considerably longer than NiMH batteries. NiMH batteries wear out much faster.

Cell Profiles - inches(mm)

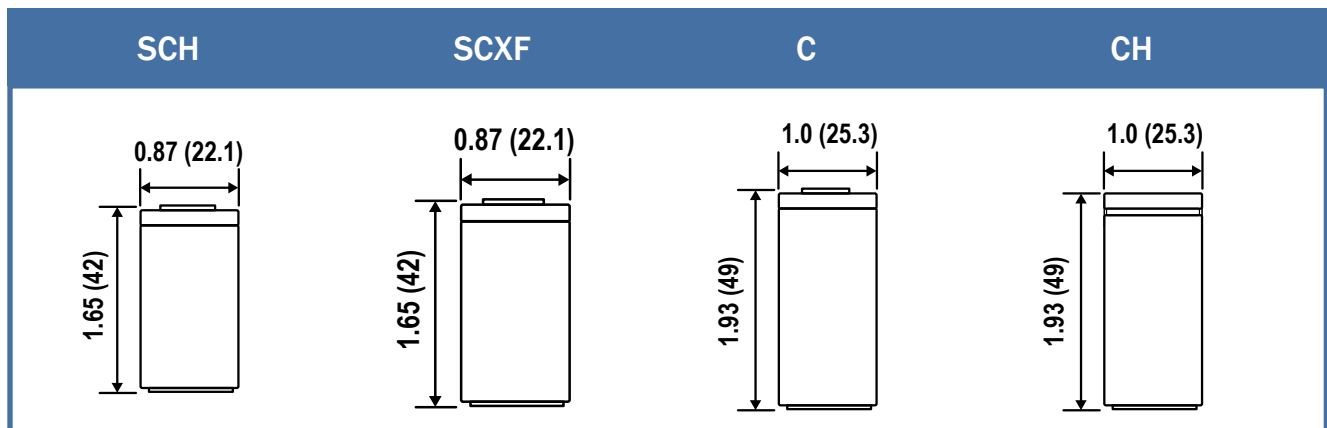
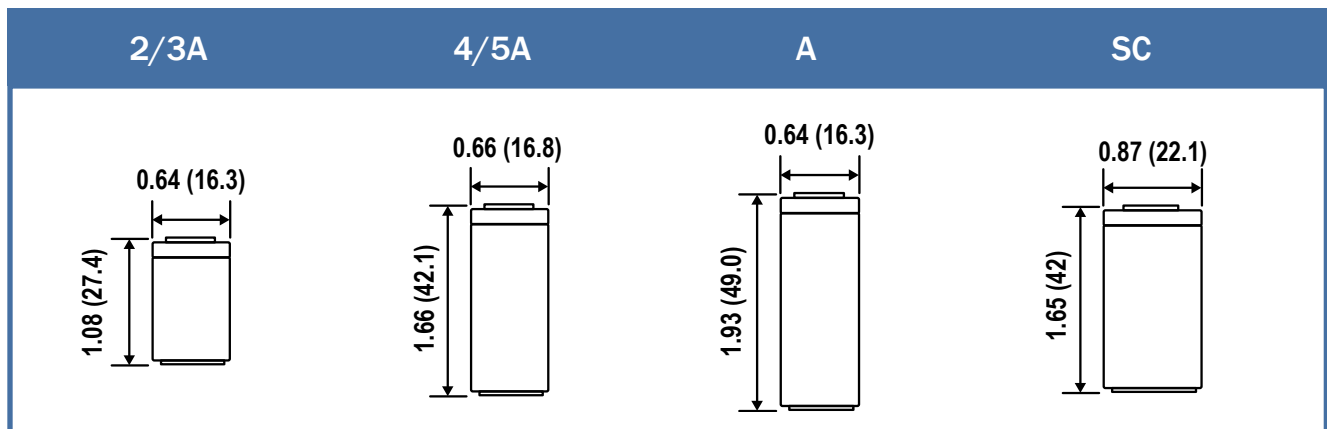
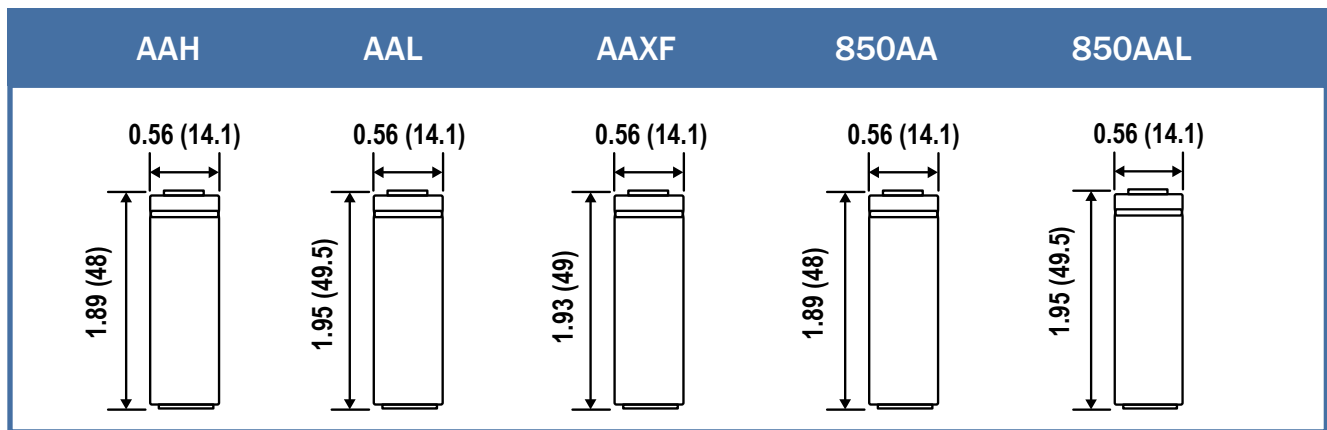
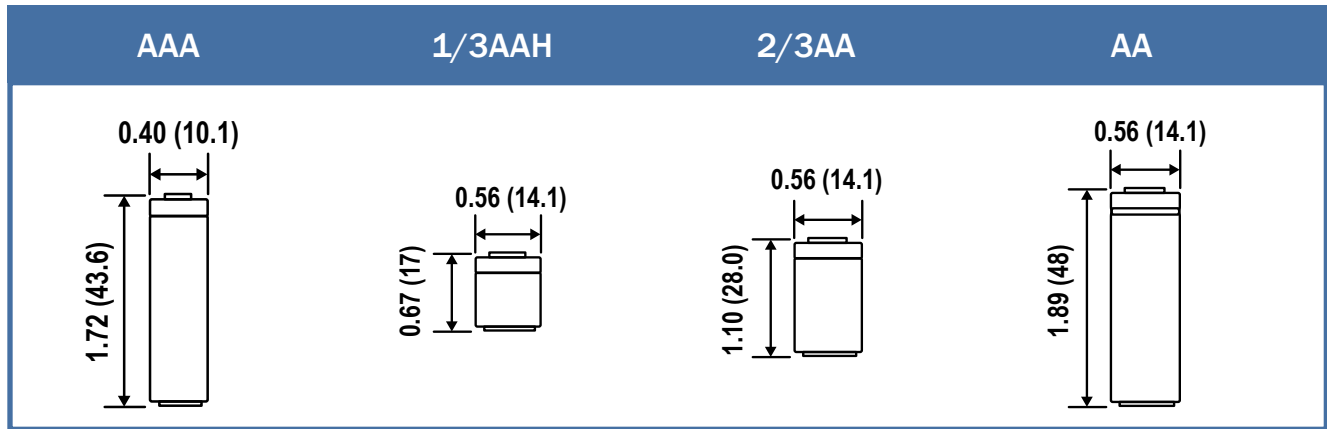



# Cell Profiles - inches(mm)

CX	1/2D	DF	DH
DL	DXF	F	PCBM2.4
PCBM3.6	NH-600AAA	NH-1600 4/5A	NH-3500 4/3A
NH-7000D	B80	B320	TR7

## Nickel Cadmium and Nickel-Metal Hydride Chargers

### PSN-Series Features

- Electronically-regulated, constant current limited 2-stage chargers for nickel cadmium and nickel metal-hydride batteries.
- Timed C/10 charge rate with automatic switching to C/40 trickle rate after fourteen hours to keep the battery fully charged. LED's indicate charge mode.
- Units are calibrated to the battery pack's specifications based on the number and mAh capacity of the cells. Assemblies of 1-12 cells and capacities of 500-5000 mAh can be charged in about 14 hours.
- The wall mount design chargers are shipped with a 6-foot (1800mm) 18-AWG output cable with 2.5mm ID barrel plug connector and feature a vented housing made of tough ABS plastic.
- To order, indicate number and capacity (mAh) of cells.  
Example: 5 cells (6 volt) - 1400 mAh.



### PSN-Series Specifications

Input Voltage Range	Width		Height		Depth		Weight		Operating Temperature
	in.	mm	in.	mm	in.	mm	lbs.	kgs.	
110 to 120 VAC, 60 Hz.	2.80	71	3.80	96	2.80	71	1.50	.68	0° to 40°C (32° to 104°F)

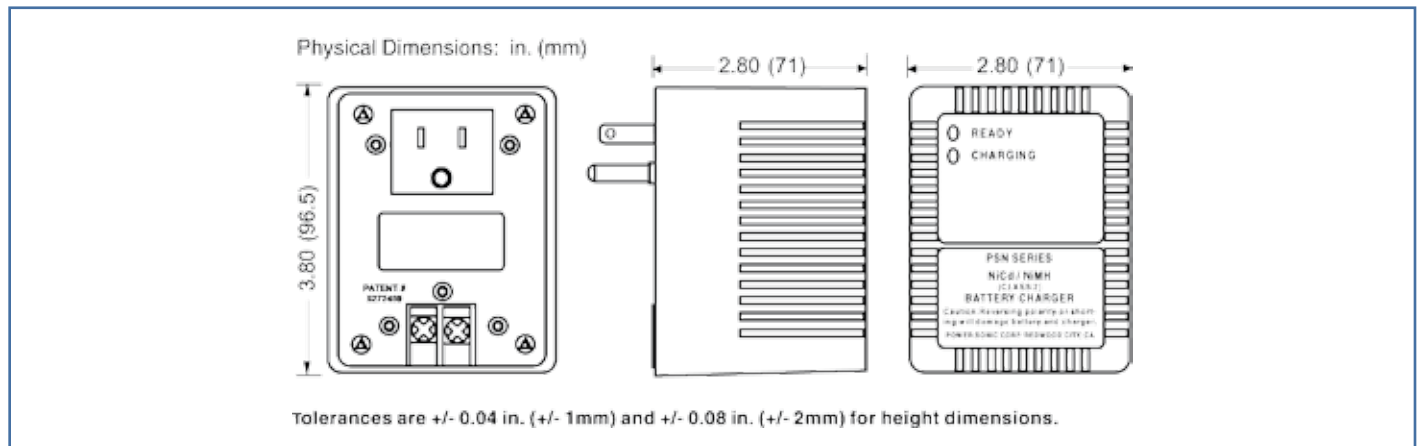

Chargers are not protected against reverse polarity connection. Reversing polarity or shorting will damage the battery and the charger.

**Note:** Operating instructions and safety procedures are available on our website: [www.power-sonic.com](http://www.power-sonic.com). Our Customer Service department will be happy to provide you with a printed copy of these instructions should you require. Please contact our Technical Department if you have any questions regarding the operation of these chargers.



## Quality is always #1

We employ IQC, PQC and ISO 9001 quality management systems to test materials, monitor manufacturing processes and evaluate finished products prior to shipment. All our batteries are 100% tested with advanced computer equipment prior to being released for sale.

Power-Sonic management and staff are committed to providing the best possible service to satisfy our customer's needs, and fulfill our undertaking to deliver top grade products on time and at a competitive price.

Our batteries meet international standards including JIS, DIN and IEC and have UL certification.

### Corporate Headquarters and Domestic Sales

Power-Sonic Corporation • 7550 Panasonic Way • San Diego, CA 92154 • USA

Phone: (619) 661-2020 • Fax: (619) 661-3650

Email Sales: [national-sales@power-sonic.com](mailto:national-sales@power-sonic.com) • Email Customer Service: [customer-service@power-sonic.com](mailto:customer-service@power-sonic.com)

### International Sales

Power-Sonic Corporation • P.O. Box 5242 • Redwood City, CA 94063 • USA

Phone: (650) 364-5001 • Fax: (650) 366-3662

Email Sales: [international-sales@power-sonic.com](mailto:international-sales@power-sonic.com)

### European Sales

Power-Sonic Europe, Ltd. • 3 Buckingham Square, Hurricane Way • Wickford, Essex SS11 8YQ • England

Phone: (1268) 560686 • Fax: (1268) 560902

Email Sales: [sales@power-sonic.co.uk](mailto:sales@power-sonic.co.uk) • Website: [www.power-sonic.co.uk](http://www.power-sonic.co.uk)

**[www.power-sonic.com](http://www.power-sonic.com)**