

SCHEMATIC OF THE HEATH DUAL TRACE OSCILLOSCOPE MODEL 10-4510/SO-4510

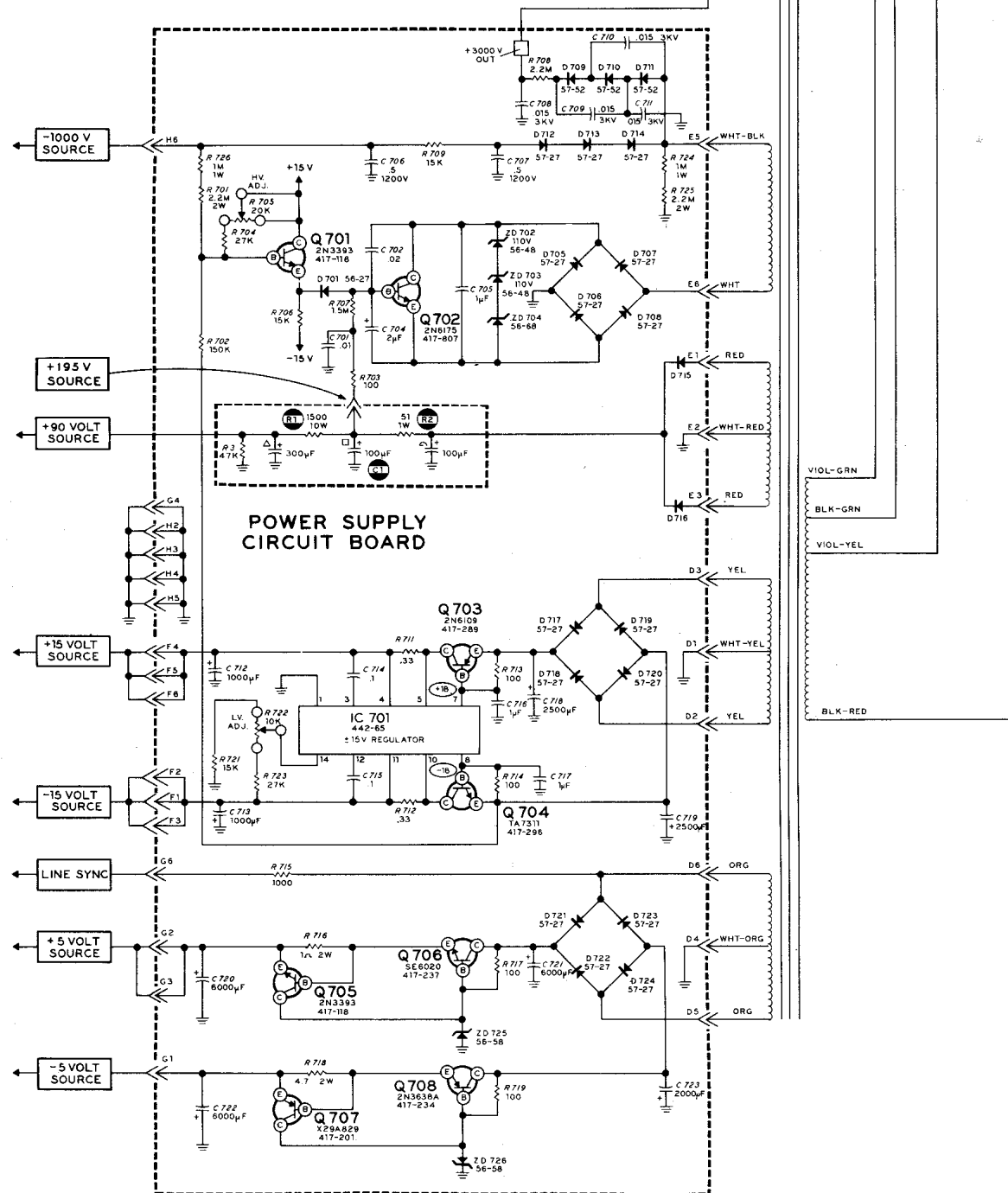

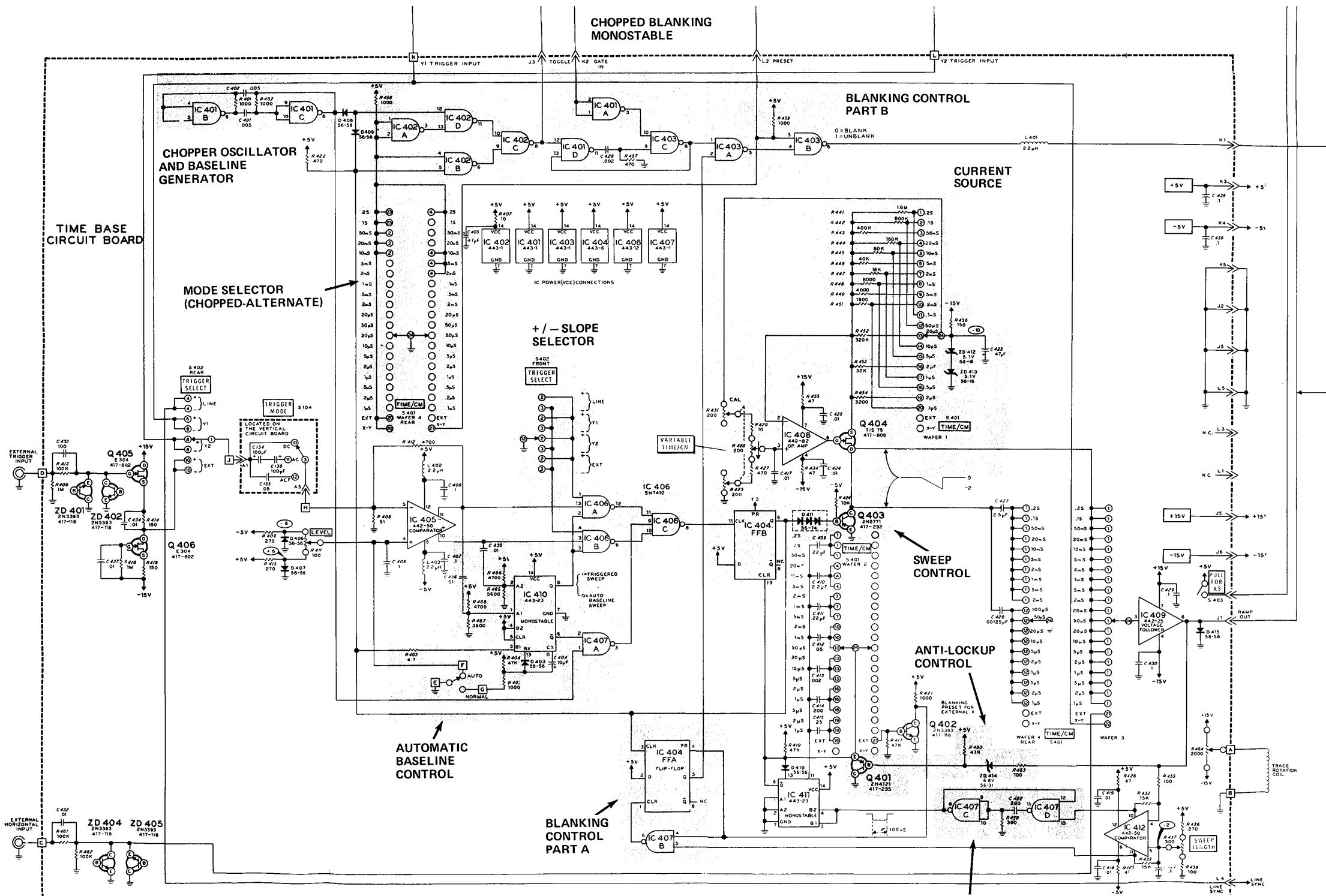

TIME BASE
CIRCUIT BOARD

CHOPPER OSCILLATOR
AND BASELINE
GENERATOR

MODE SELECTOR
(CHOPPED-ALTERNATE)

CHOPPED BLONOSTABLE

BLANKING CONTROL
PART B

CURRENT
SOURCE

+ / - SLOPE
SELECTOR

SWEPT
CONTROL

ANTI-LOCKUP
CONTROL

AUTOMATIC
BASELINE
CONTROL

BLANKING CONTROL
PART A

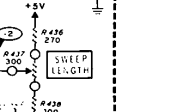
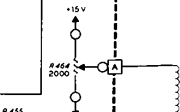
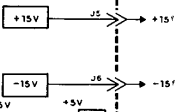
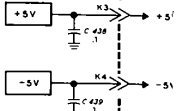

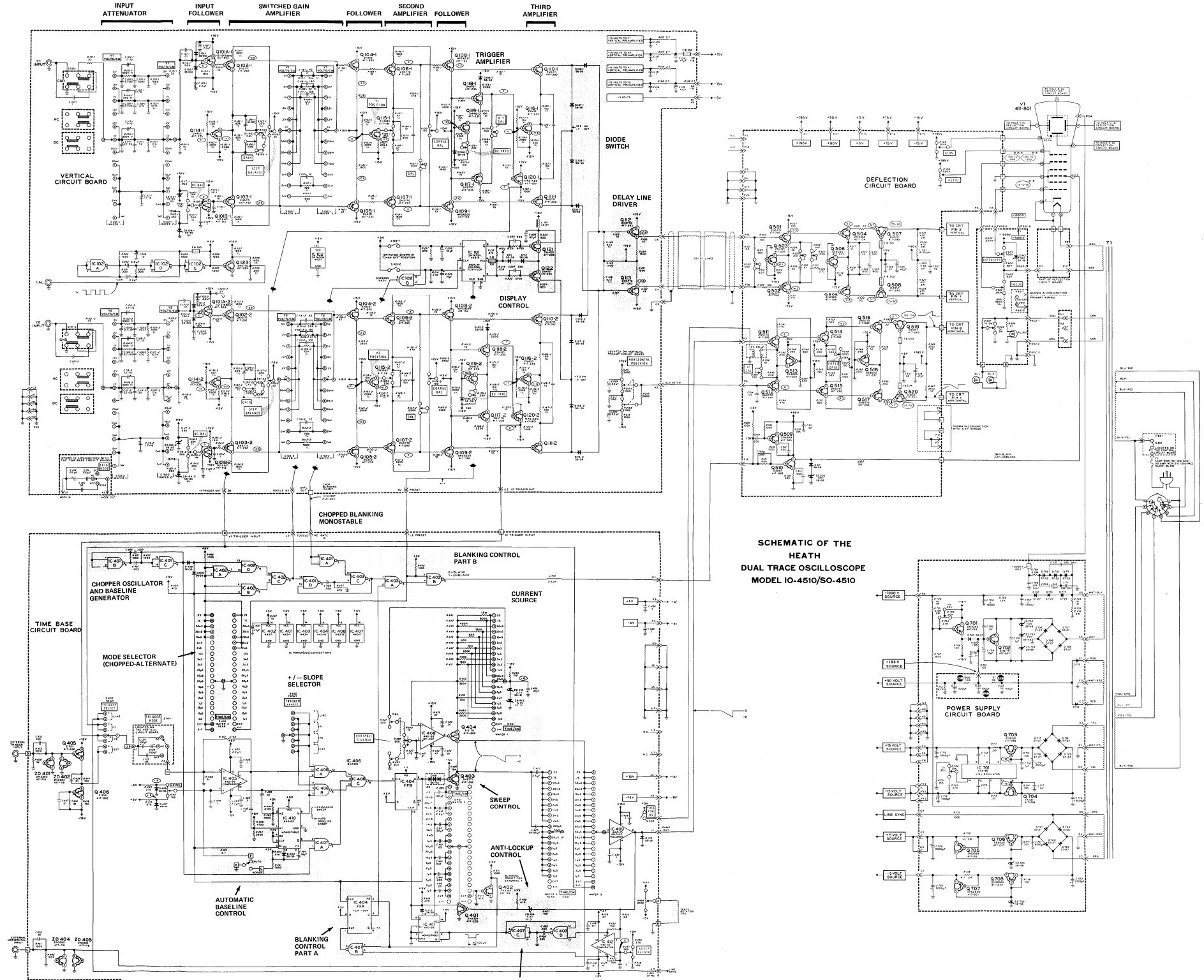

**SCHEMATIC OF THE
HEATH
DUAL TRACE OSCILLOSCOPE
MODEL IO-4510/50-4510**