

DATA SHEET

BF998; BF998R Silicon N-channel dual-gate MOS-FETs

Product specification
Supersedes data of April 1991
File under Discrete Semiconductors, SC07

1996 Aug 01

Silicon N-channel dual-gate MOS-FETs

BF998; BF998R

FEATURES

- Short channel transistor with high forward transfer admittance to input capacitance ratio
- Low noise gain controlled amplifier up to 1 GHz.

APPLICATIONS

- VHF and UHF applications with 12 V supply voltage, such as television tuners and professional communications equipment.

DESCRIPTION

Depletion type field effect transistor in a plastic microminiature SOT143 or SOT143R package with source and substrate interconnected. The transistors are protected against excessive input voltage surges by integrated back-to-back diodes between gates and source.

CAUTION

The device is supplied in an antistatic package. The gate-source input must be protected against static discharge during transport or handling.

PINNING

PIN	SYMBOL	DESCRIPTION
1	s, b	source
2	d	drain
3	g ₂	gate 2
4	g ₁	gate 1

QUICK REFERENCE DATA

SYMBOL	PARAMETER	CONDITIONS	TYP.	MAX.	UNIT
V _{DS}	drain-source voltage		–	12	V
I _D	drain current		–	30	mA
P _{tot}	total power dissipation		–	200	mW
y _{fs}	forward transfer admittance		24	–	mS
C _{ig1-s}	input capacitance at gate 1		2.1	–	pF
C _{rs}	reverse transfer capacitance	f = 1 MHz	25	–	fF
F	noise figure	f = 800 MHz	1	–	dB
T _j	operating junction temperature		–	150	°C

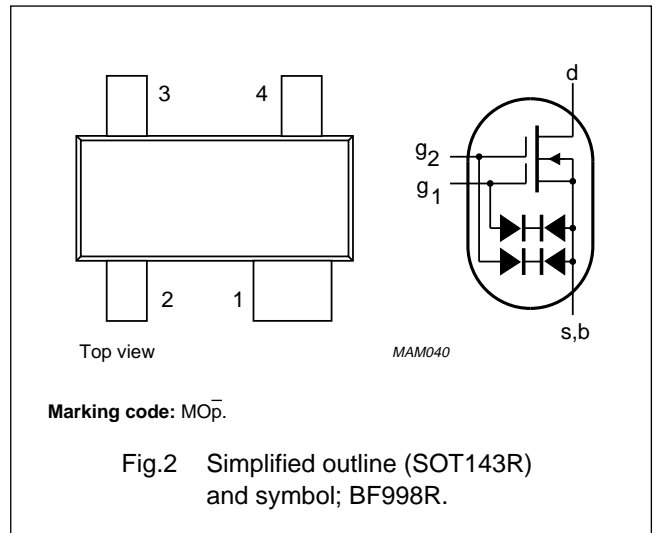
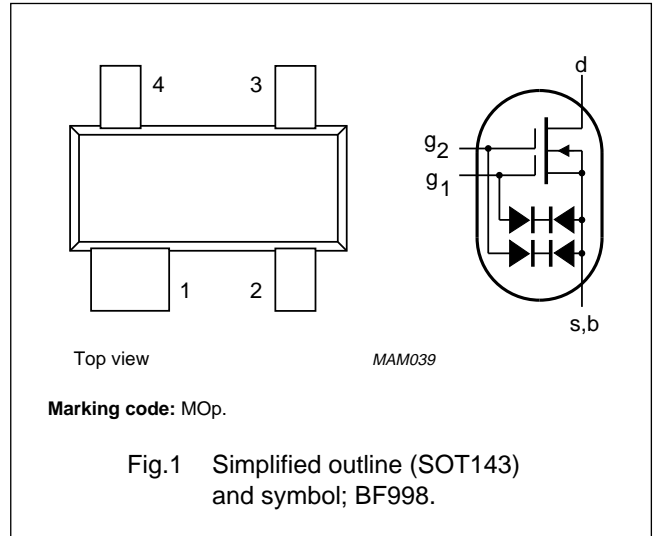

Silicon N-channel dual-gate MOS-FETs

BF998; BF998R

LIMITING VALUES

In accordance with the Absolute Maximum Rating System (IEC 134).

SYMBOL	PARAMETER	CONDITIONS	MIN.	MAX.	UNIT
V_{DS}	drain-source voltage		–	12	V
I_D	drain current		–	30	mA
$\pm I_{G1}$	gate 1 current		–	10	mA
$\pm I_{G2}$	gate 2 current		–	10	mA
P_{tot}	total power dissipation; BF998	up to $T_{amb} = 60\text{ }^\circ\text{C}$; see Fig.3; note 1	–	200	mW
		up to $T_{amb} = 50\text{ }^\circ\text{C}$; see Fig.3; note 2	–	200	mW
P_{tot}	total power dissipation; BF998R	up to $T_{amb} = 50\text{ }^\circ\text{C}$; see Fig.4; note 1	–	200	mW
T_{stg}	storage temperature		–65	+150	$^\circ\text{C}$
T_j	operating junction temperature		–	150	$^\circ\text{C}$

Notes

1. Device mounted on a ceramic substrate, 8 mm × 10 mm × 0.7 mm.
2. Device mounted on a printed-circuit board.

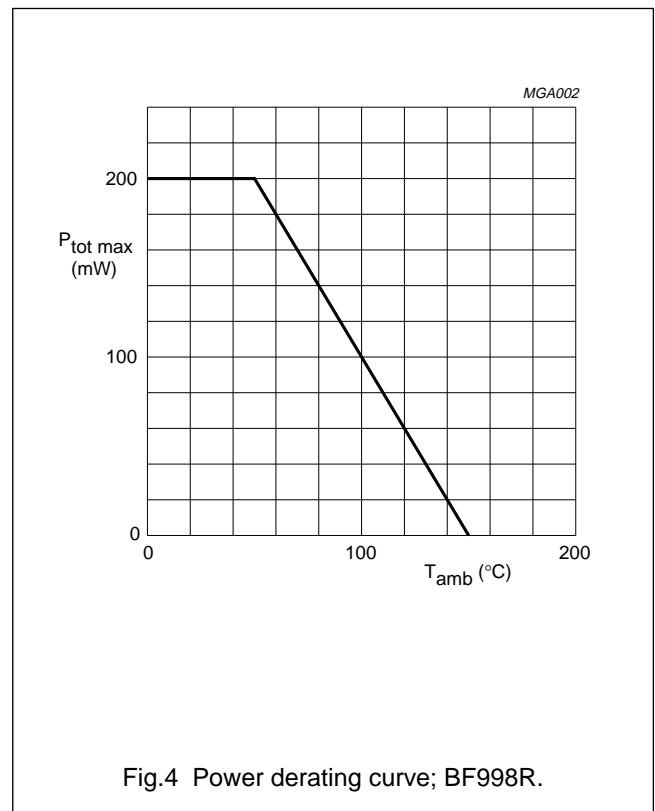
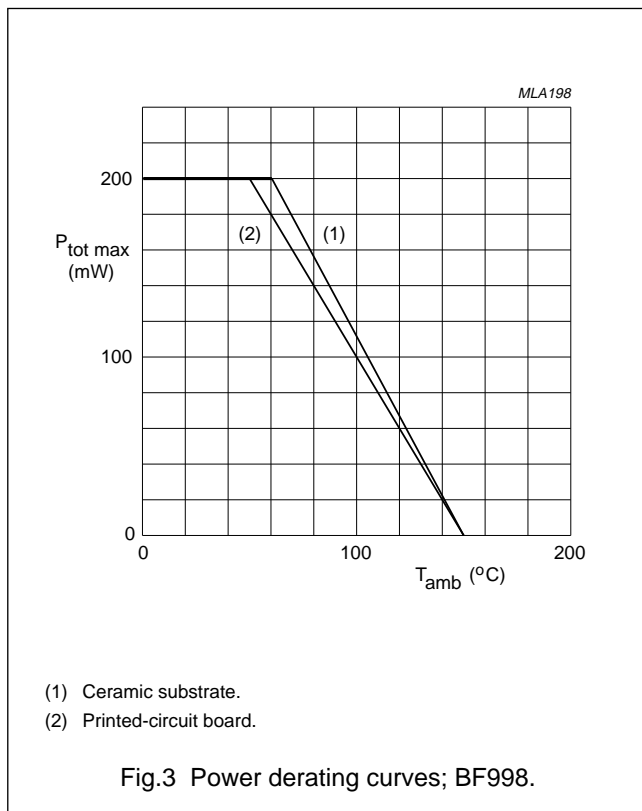

Silicon N-channel dual-gate MOS-FETs

BF998; BF998R

THERMAL CHARACTERISTICS

SYMBOL	PARAMETER	CONDITIONS	VALUE	UNIT
$R_{th\ j-a}$	thermal resistance from junction to ambient in free air; BF998	note 1	460	K/W
		note 2	500	K/W
$R_{th\ j-a}$	thermal resistance from junction to ambient in free air; BF998R	note 1	500	K/W

Notes

- Device mounted on a ceramic substrate, 8 mm × 10 mm × 0.7 mm.
- Device mounted on a printed-circuit board.

STATIC CHARACTERISTICS

$T_j = 25\text{ }^\circ\text{C}$; unless otherwise specified.

SYMBOL	PARAMETER	CONDITIONS	MIN.	MAX.	UNIT
$\pm V_{(BR)G1-SS}$	gate 1-source breakdown voltage	$V_{G2-S} = V_{DS} = 0$; $I_{G1-SS} = \pm 10\text{ mA}$	6	20	V
$\pm V_{(BR)G2-SS}$	gate 2-source breakdown voltage	$V_{G1-S} = V_{DS} = 0$; $I_{G2-SS} = \pm 10\text{ mA}$	6	20	V
$-V_{(P)G1-S}$	gate 1-source cut-off voltage	$V_{G2-S} = 4\text{ V}$; $V_{DS} = 8\text{ V}$; $I_D = 20\text{ }\mu\text{A}$	–	2.0	V
$-V_{(P)G2-S}$	gate 2-source cut-off voltage	$V_{G1-S} = 0$; $V_{DS} = 8\text{ V}$; $I_D = 20\text{ }\mu\text{A}$	–	1.5	V
I_{DSS}	drain-source current	$V_{G2-S} = 4\text{ V}$; $V_{DS} = 8\text{ V}$; $V_{G1-S} = 0$; note 1	2	18	mA
$\pm I_{G1-SS}$	gate 1 cut-off current	$V_{G2-S} = V_{DS} = 0$; $V_{G1-S} = \pm 5\text{ V}$	–	50	nA
$\pm I_{G2-SS}$	gate 2 cut-off current	$V_{G1-S} = V_{DS} = 0$; $V_{G2-S} = \pm 5\text{ V}$	–	50	nA

Note

- Measured under pulse condition.

DYNAMIC CHARACTERISTICS

Common source; $T_{amb} = 25\text{ }^\circ\text{C}$; $V_{DS} = 8\text{ V}$; $V_{G2-S} = 4\text{ V}$; $I_D = 10\text{ mA}$.

SYMBOL	PARAMETER	CONDITIONS	MIN.	TYP.	MAX.	UNIT
$ y_{fs} $	forward transfer admittance	$f = 1\text{ kHz}$	21	24	–	mS
C_{ig1-s}	input capacitance at gate 1	$f = 1\text{ MHz}$	–	2.1	2.5	pF
C_{ig2-s}	input capacitance at gate 2	$f = 1\text{ MHz}$	–	1.2	–	pF
C_{os}	output capacitance	$f = 1\text{ MHz}$	–	1.05	–	pF
C_{rs}	reverse transfer capacitance	$f = 1\text{ MHz}$	–	25	–	fF
F	noise figure	$f = 200\text{ MHz}$; $G_S = 2\text{ mS}$; $B_S = B_{Sopt}$	–	0.6	–	dB
		$f = 800\text{ MHz}$; $G_S = 3.3\text{ mS}$; $B_S = B_{Sopt}$	–	1.0	–	dB

Silicon N-channel dual-gate MOS-FETs

BF998; BF998R

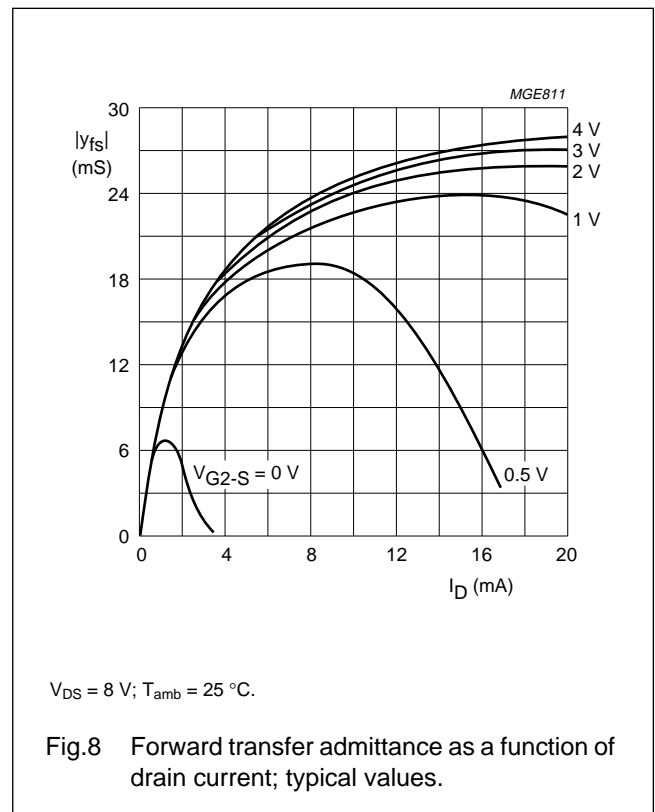
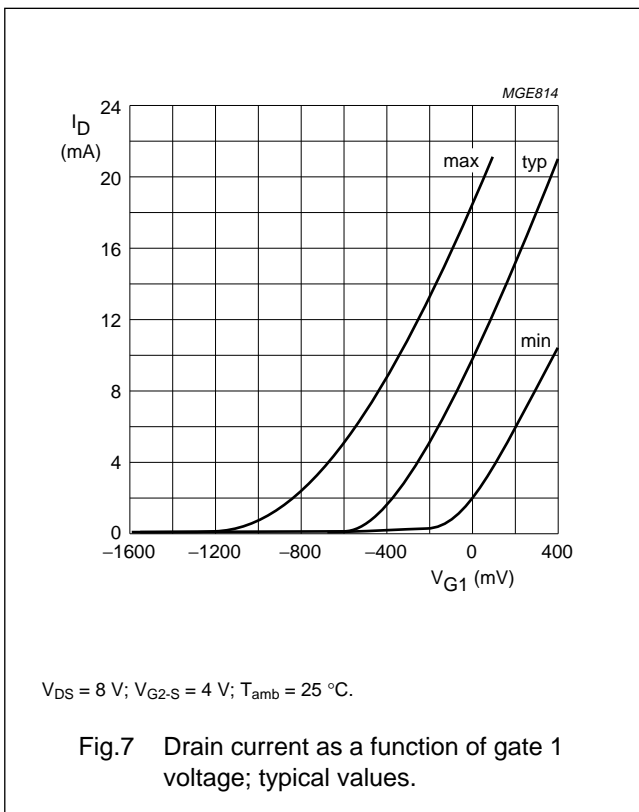
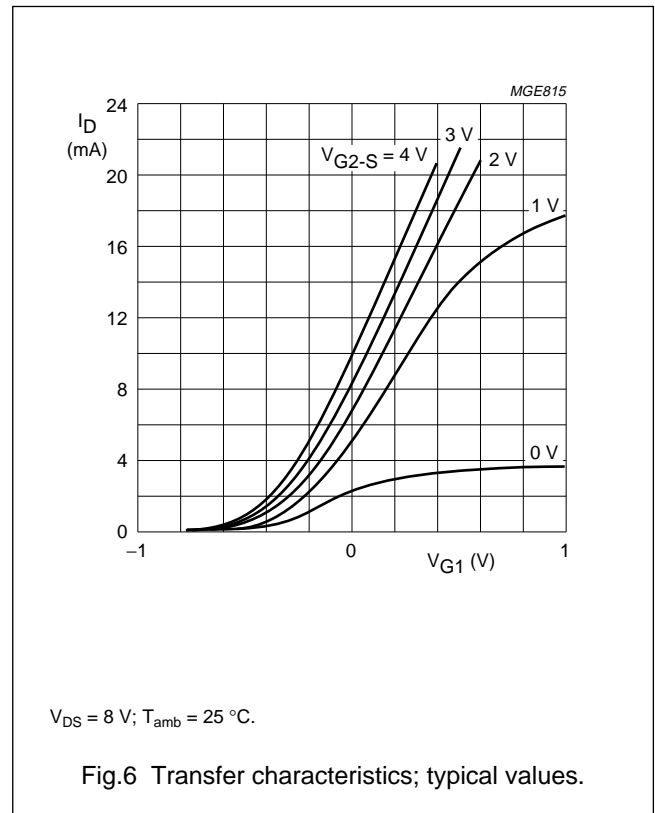
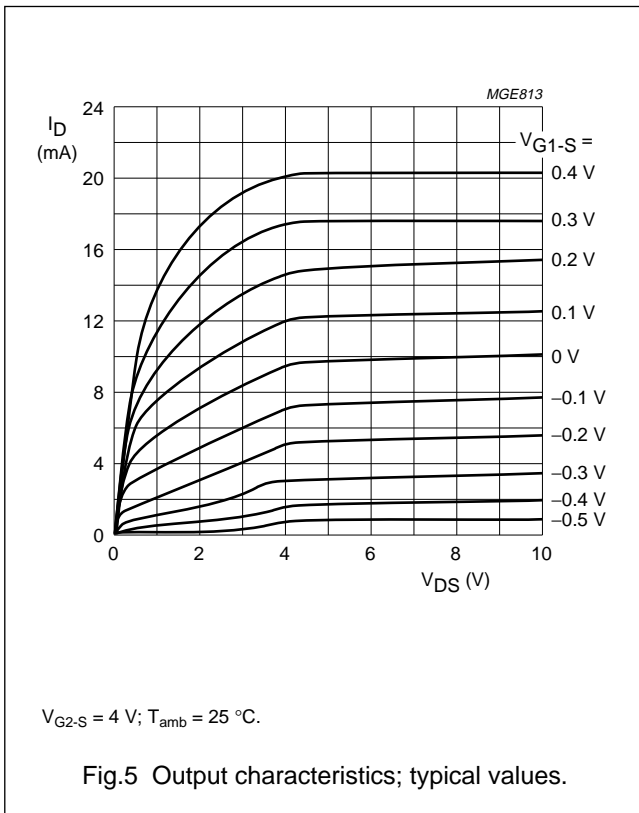

Silicon N-channel dual-gate MOS-FETs

BF998; BF998R

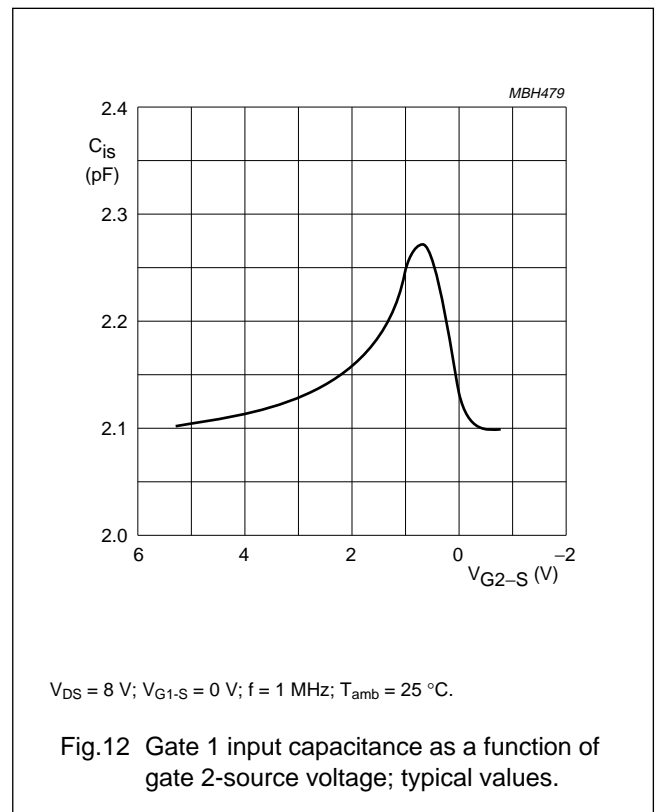
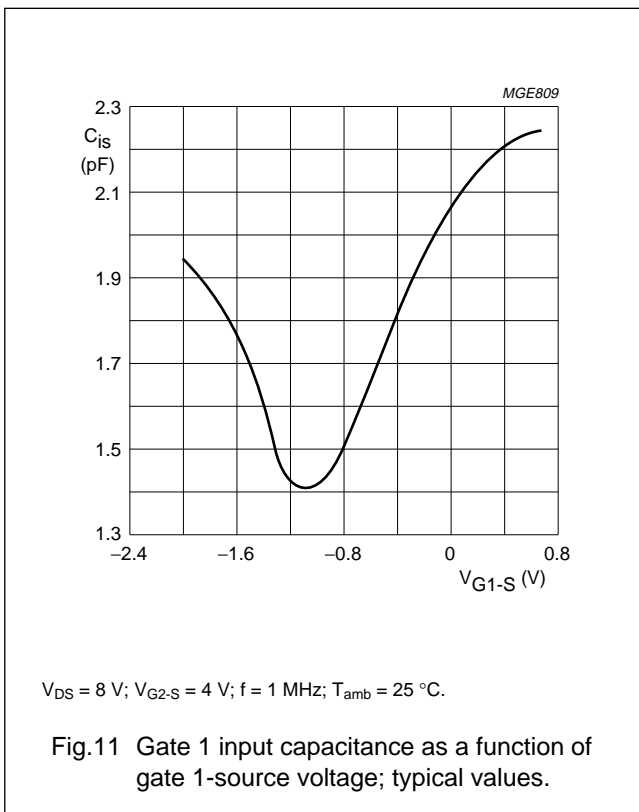
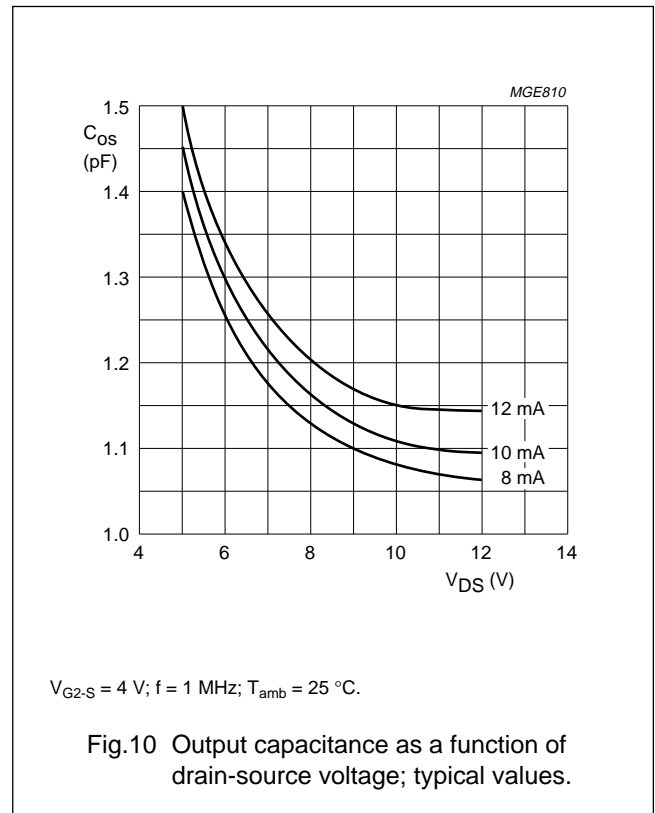
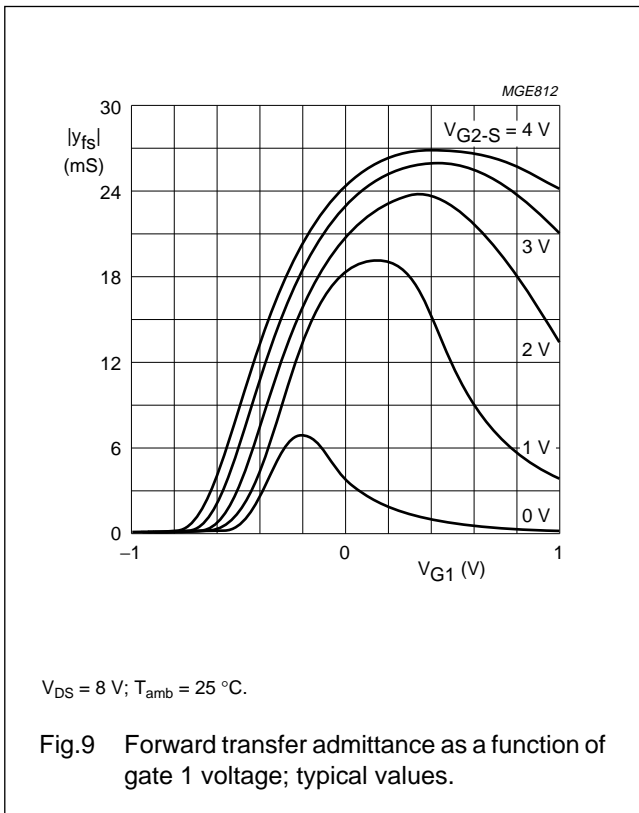

Silicon N-channel dual-gate MOS-FETs

BF998; BF998R

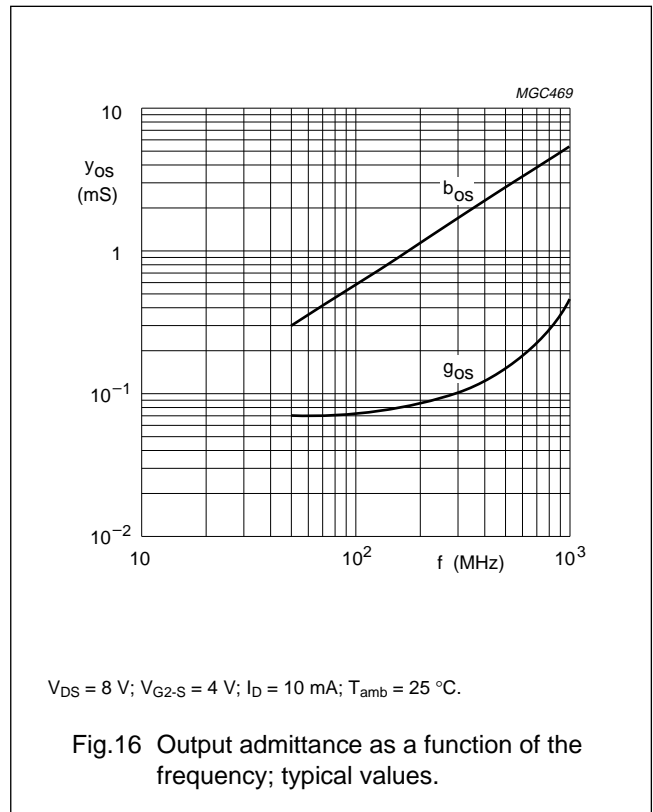
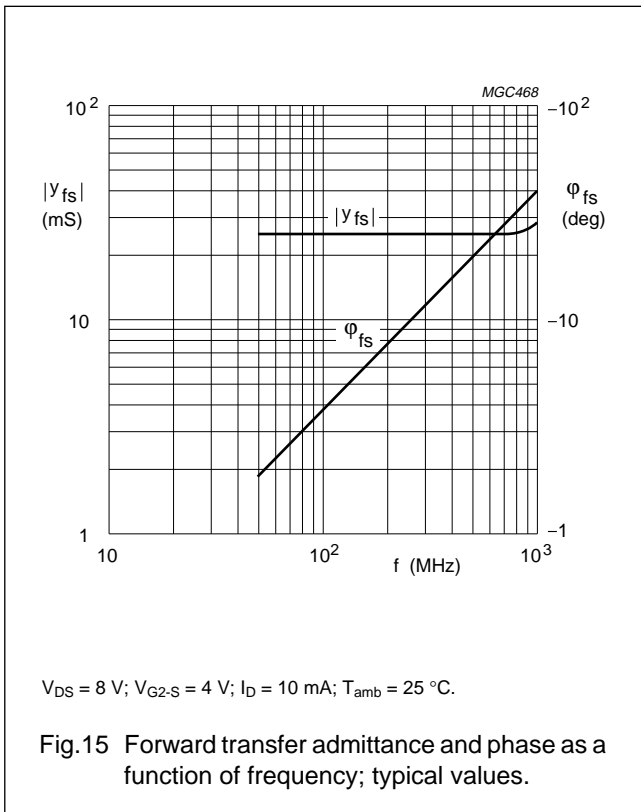
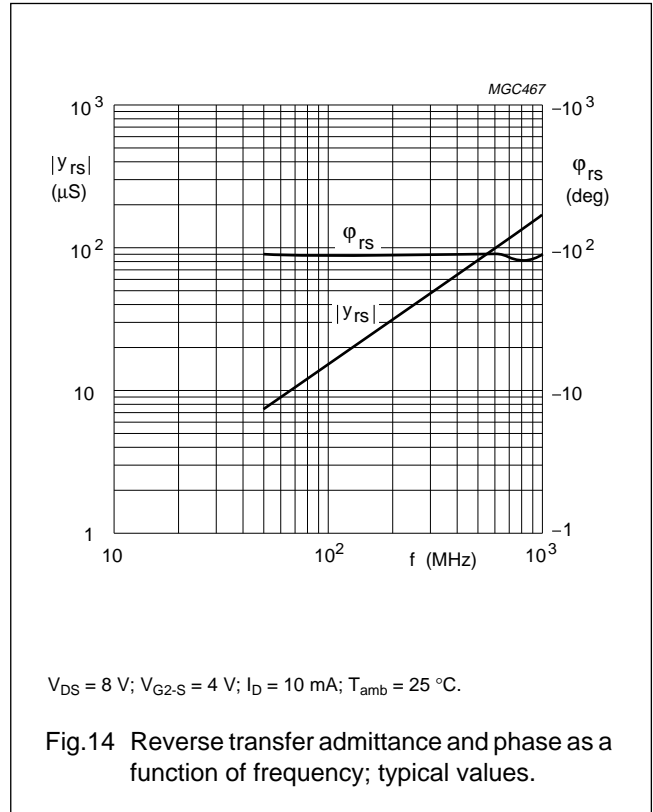
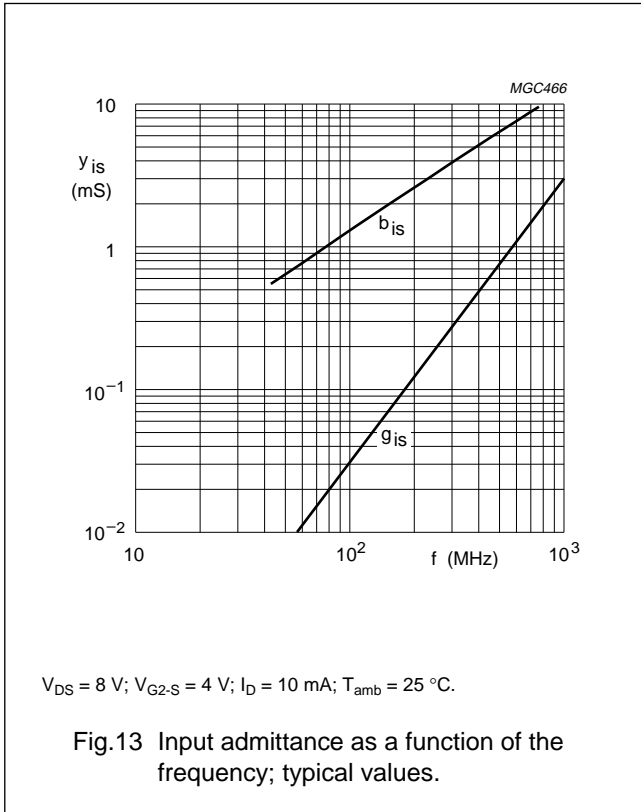

Silicon N-channel dual-gate MOS-FETs

BF998; BF998R

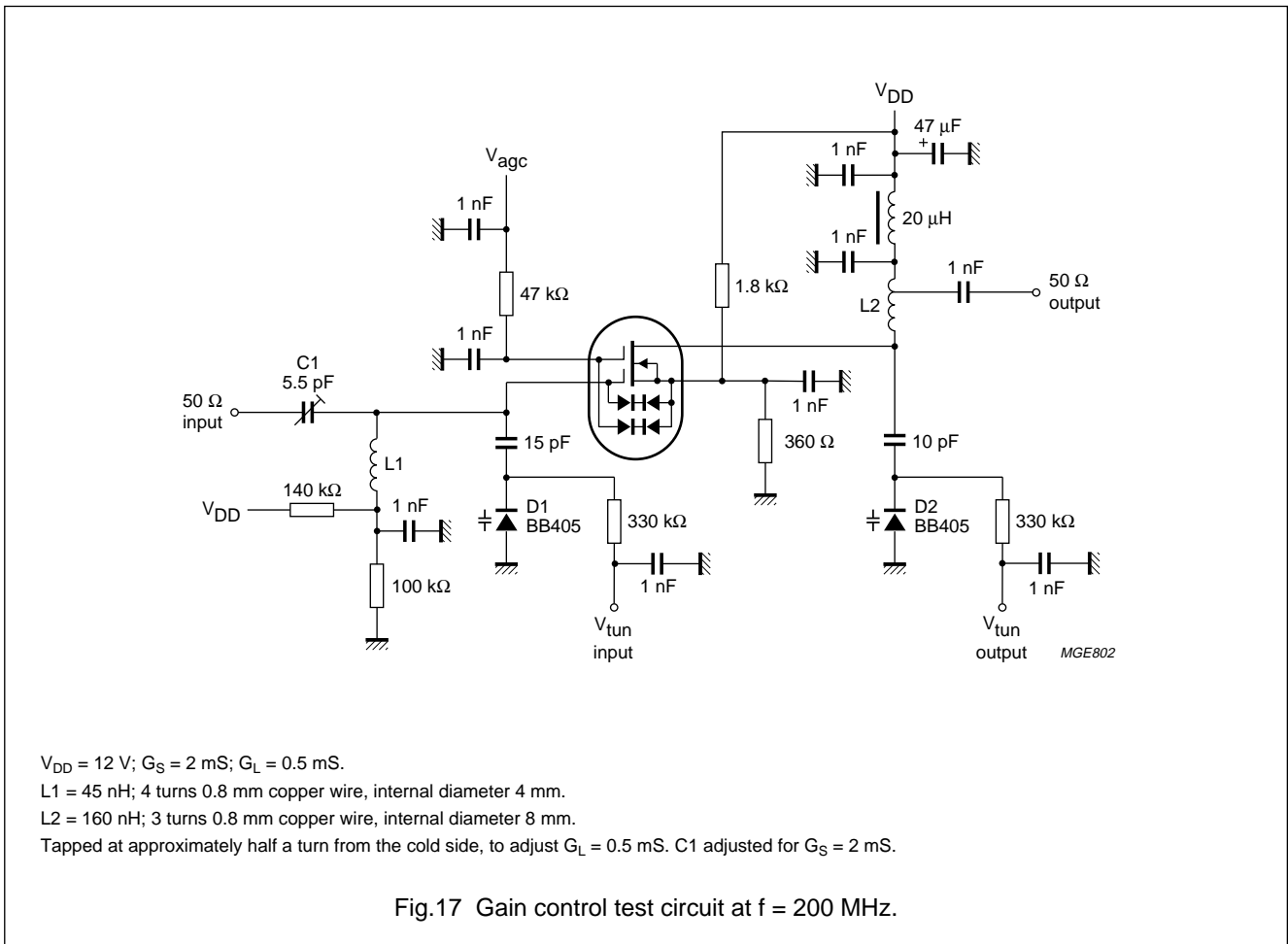
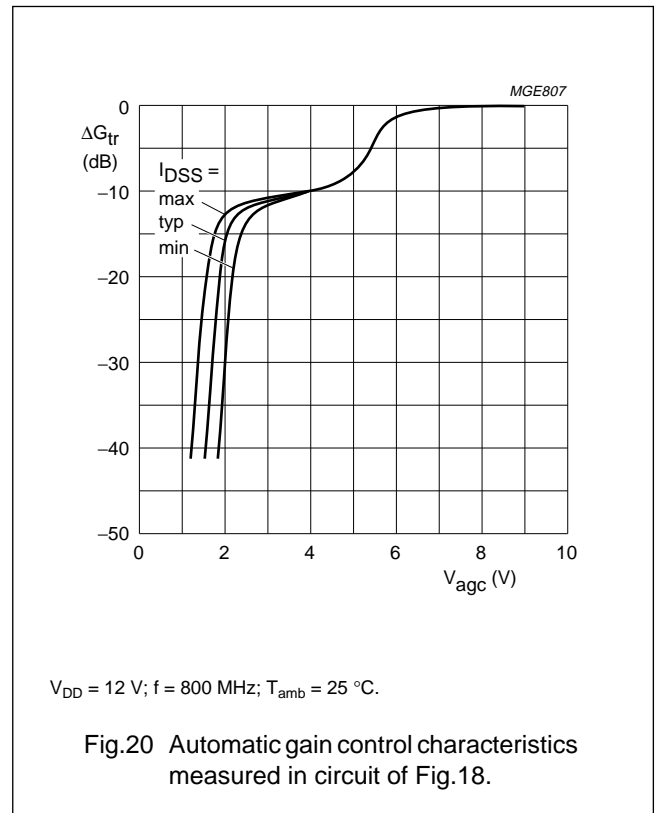
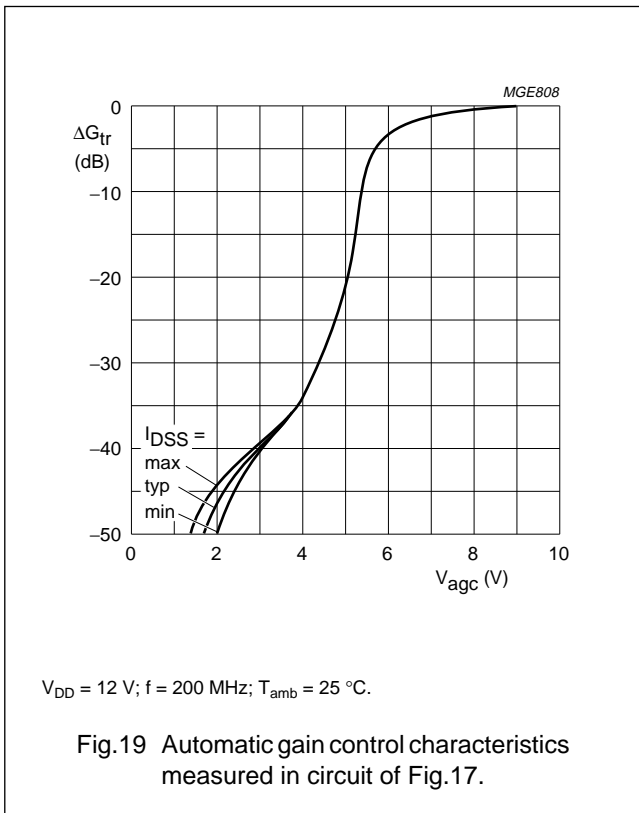

Fig.17 Gain control test circuit at $f = 200\text{ MHz}$.

Silicon N-channel dual-gate MOS-FETs

BF998; BF998R



Silicon N-channel dual-gate MOS-FETs

BF998; BF998R

PACKAGE OUTLINES

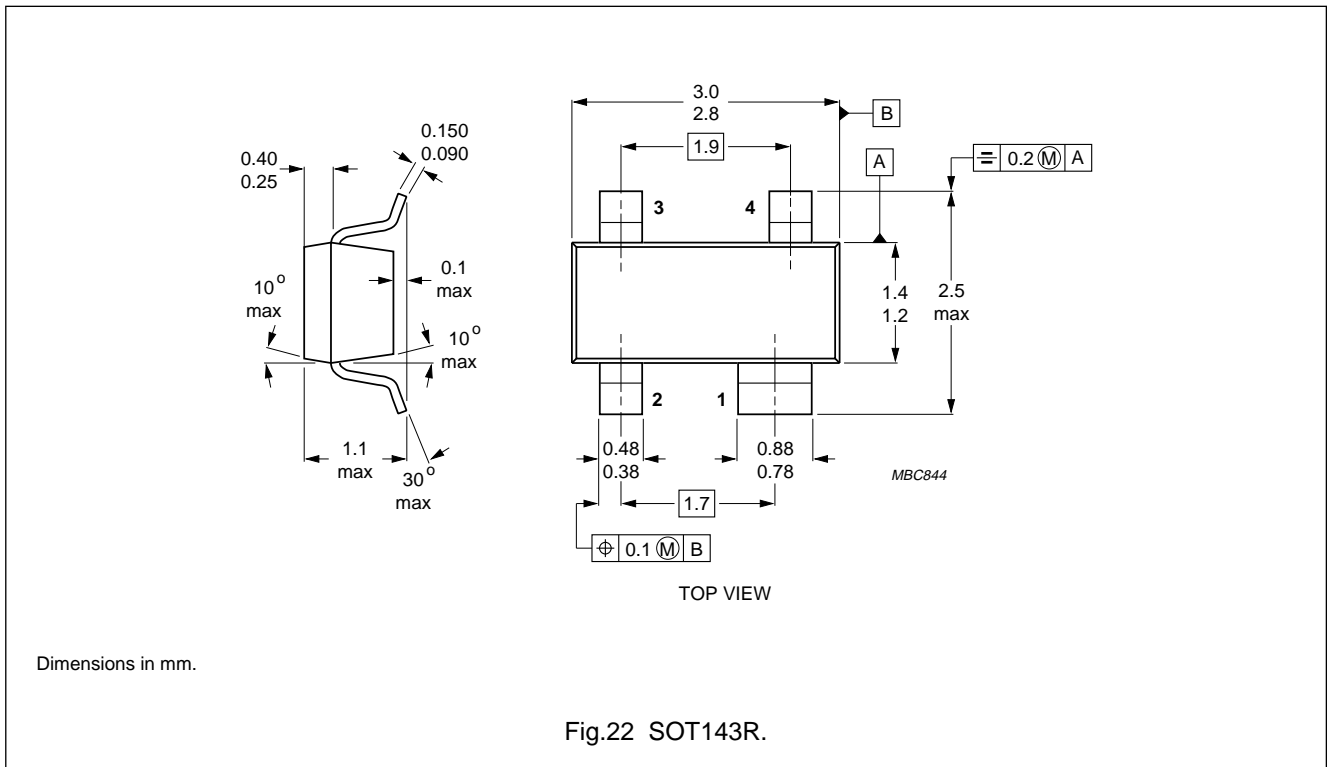
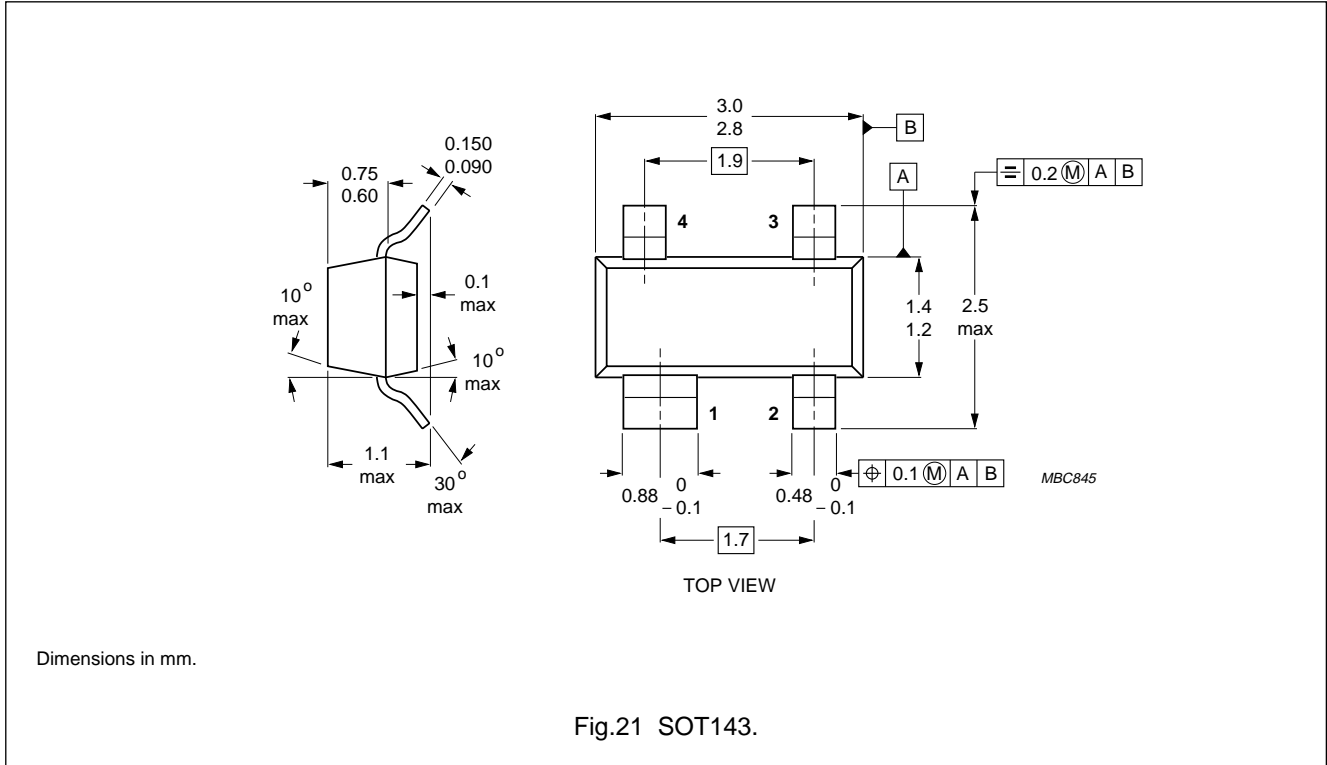

Silicon N-channel dual-gate MOS-FETs

BF998; BF998R

DEFINITIONS

Data Sheet Status	
Objective specification	This data sheet contains target or goal specifications for product development.
Preliminary specification	This data sheet contains preliminary data; supplementary data may be published later.
Product specification	This data sheet contains final product specifications.
Limiting values	
Limiting values given are in accordance with the Absolute Maximum Rating System (IEC 134). Stress above one or more of the limiting values may cause permanent damage to the device. These are stress ratings only and operation of the device at these or at any other conditions above those given in the Characteristics sections of the specification is not implied. Exposure to limiting values for extended periods may affect device reliability.	
Application information	
Where application information is given, it is advisory and does not form part of the specification.	

LIFE SUPPORT APPLICATIONS

These products are not designed for use in life support appliances, devices, or systems where malfunction of these products can reasonably be expected to result in personal injury. Philips customers using or selling these products for use in such applications do so at their own risk and agree to fully indemnify Philips for any damages resulting from such improper use or sale.