

SANYO	No.2725A	LA1145, 1145M
Quadrature Detector for Car Radio FM IF System		

Features

1. On-chip IF count buffer circuit and microprocessor-controlled switch circuit for ETR.
2. Compared to the LA1140, the LA1145,1145M offer:
 - ① Improved signal meter output linearity;
 - ② Improved band mute temperature stability;
 - ③ Improved S/N ratio;
 - ④ Improved sound quality at weak signal input when noise is present, and;
 - ⑤ Improved AMR characteristics during weak signal input.
3. Reduced parts' count simplifies design:
 - ① On-chip IF count buffer circuit;
 - ② On-chip SD circuit -- sensitivity can be set independently of soft mute characteristics, and;
 - ③ Variable S-meter gradient -- three pin S-meter output (pins 5,16 and 17) facilitates independent control of SNC and HCC.

[LA1145]

Maximum Ratings at Ta = 25°C

Maximum Supply Voltage	V _{CC} max	Pin 12		14	V
Maximum Supply Current	I _{CC} max	Pin 12		45	mA
Allowable Power Dissipation	P _d max	Ta = 65°C		630	mW
		Ta = 70°C		590	mW
Operating Temperature	Topr			-20 to +70	°C
Storage Temperature	Tstg			-40 to +150	°C

Operating Conditions at Ta = 25°C

Recommended Supply Voltage	V _{CC}			8	V
Operating Voltage Range	V _{CC} op			7.5 to 14	V

Operating Characteristics at Ta = 25°C, V_{CC} = 8V, f_{in} = 10.7MHz

			min	typ	max unit
Quiescent Current	I _{cco}	v _{in} = 0dBμ	18	26	36 mA
Current Dissipation	I _{CC}	v _{in} = 100dBμ	20	29	40 mA
Demodulation Output	V _o	v _{in} = 100dBμ, 400Hz tone, 100%	300	400	520 mVrms
Total Harmonic Distortion THD		v _{in} = 100dBμ, 400Hz tone, 100%, single tuning coil	0.3	0.8	%

Continued on next page.

Package Dimensions

(unit: mm)

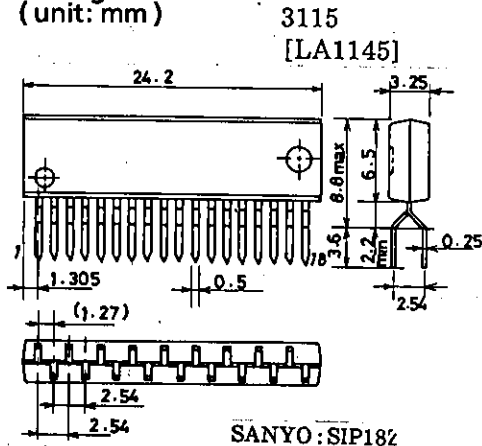

Package Dimensions

(unit: mm)

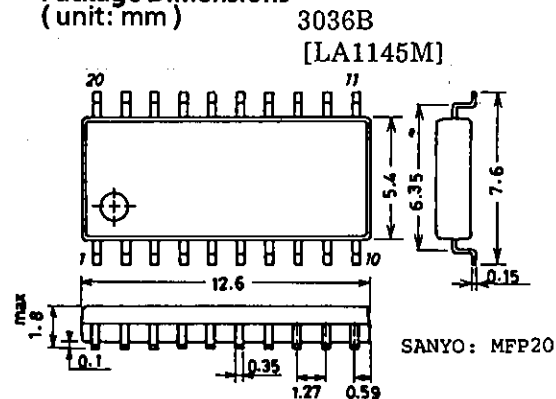

LA1145,1145M

Continued from preceding page.

			min	typ	max	unit
Signal to Noise Ratio	S/N	$v_{in} = 100\text{dB}\mu, 400\text{Hz tone}, 100\%$	79	85		dB
Input Limiting Voltage	v_i (lim)	400Hz tone, 100%, soft mute ON	34	40	46	dB μ
Muting Sensitivity	V_i (mute)	$V_{15} = 2\text{V}$	30	36	42	dB μ
Muting Bandwidth	BW (mute)	$v_{in} = 100\text{dB}\mu, V_{18} \leq 0.3\text{V}$	140	190	280	kHz
Muting Attenuation	mute (1)	$v_{in} = 100\text{dB}\mu, V_{15} = 2\text{V},$ 400Hz tone, 100%	10	15	20	dB
	mute (2)	$v_{in} = 100\text{dB}\mu, V_{15} = 4\text{V},$ 400Hz tone, 100%	25	29	33	dB
Signal Strength	V_{16-0}	$v_{in} = 0\text{dB}\mu, R_A = 10\text{k}\Omega, \text{pin } 16$	0	0.1	0.4	V
Indication Output	V_{16-50}	$v_{in} = 50\text{dB}\mu, R_A = 10\text{k}\Omega, \text{pin } 16$	1.4	2.3	3.2	V
	V_{16-70}	$v_{in} = 70\text{dB}\mu, R_A = 10\text{k}\Omega, \text{pin } 16$	2.5	4.5	5.5	V
	V_{16-100}	$v_{in} = 100\text{dB}\mu, R_A = 10\text{k}\Omega, \text{pin } 16$	5.0	5.5	6.0	V
	Muting Drive Output	V_{15-0}	$v_{in} = 0\text{dB}\mu, \text{pin } 15$	4.0	4.8	5.5
	V_{15-100}	$v_{in} = 100\text{dB}\mu, \text{pin } 15$	0	0	0.3	V
AM Rejection Ratio	AMR	$v_{in} = 100\text{dB}\mu, 1\text{kHz tone}, 30\% \text{ AM}$	57	70		dB
Offset Voltage	V_{7-11}	$v_{in} = 0\text{dB}\mu, \text{pins } 7 \text{ to } 11$	-0.25	0	0.25	V
	V_{8-11}	$v_{in} = 0\text{dB}\mu, \text{pins } 8 \text{ to } 11$	-0.5	0	0.5	V
SD Sensitivity	V_{SD}	Pin 18	50	58	66	dB μ
IF Count Output Level	V_i (IF)	$v_{in} = 100\text{dB}\mu, \text{pin } 13, C_L = 10\text{pF}$	110	180	280	mVrms

[LA1145M]

Maximum Ratings at $T_a = 25^\circ\text{C}$

				unit
Maximum Supply Voltage	V_{CC} max	Pin 13	14	V
Maximum Supply Current	I_{CC} max	Pin 13	45	mA
Allowable Power Dissipation	P_d max	$T_a = 70^\circ\text{C}, \text{mounted on PC board}$	630	mW
		$T_a = 25^\circ\text{C}, \text{mounted on PC board}$	630	mW
Operating Temperature	T_{opr}		-20 to +70	$^\circ\text{C}$
Storage Temperature	T_{stg}		-40 to +125	$^\circ\text{C}$

Operating Conditions at $T_a = 25^\circ\text{C}$

				unit
Recommended Supply Voltage	V_{CC}		8	V
Operating Voltage Range	V_{CC} op		7.5 to 14	V

Operating Characteristics at $T_a = 25^\circ\text{C}, V_{CC} = 8\text{V}, f_{in} = 10.7\text{MHz}$

			min	typ	max	unit
Quiescent Current	I_{cco}	$v_{in} = 0\text{dB}\mu$	18	26	36	mA
Current Dissipation	I_{CC}	$v_{in} = 100\text{dB}\mu$	20	29	40	mA
Demodulation Output	V_o	$v_{in} = 100\text{dB}\mu, 400\text{Hz tone}, 100\%$	300	400	520	mVrms
Total Harmonic Distortion	THD	$v_{in} = 100\text{dB}\mu, 400\text{Hz tone}, 100\%$, single tuning coil		0.3	0.8	%
Signal to Noise Ratio	S/N	$v_{in} = 100\text{dB}\mu, 400\text{Hz tone}, 100\%$	79	85		dB
Input Limiting Voltage	v_i (lim)	400Hz tone, 100%, soft mute ON	34	40	46	dB μ
Muting Sensitivity	V_i (mute)	$V_{16} = 2\text{V}$	30	36	42	dB μ
Muting Bandwidth	BW (mute)	$v_{in} = 100\text{dB}\mu, V_{19} \leq 0.3\text{V}$	140	190	280	kHz
Muting Attenuation	mute (1)	$v_{in} = 100\text{dB}\mu, V_{16} = 2\text{V},$ 400Hz tone, 100%	10	15	20	dB
	mute (2)	$v_{in} = 100\text{dB}\mu, V_{16} = 4\text{V},$ 400Hz tone, 100%	25	29	33	dB
Signal Strength	V_{17-0}	$v_{in} = 0\text{dB}\mu, R_{16} = 10\text{k}\Omega, \text{pin } 17$	0	0.1	0.4	V
Indication Output	V_{17-50}	$v_{in} = 50\text{dB}\mu, R_{16} = 10\text{k}\Omega, \text{pin } 17$	1.4	2.3	3.2	V
	V_{17-70}	$v_{in} = 70\text{dB}\mu, R_{16} = 10\text{k}\Omega, \text{pin } 17$	2.5	4.5	5.5	V
	V_{17-100}	$v_{in} = 100\text{dB}\mu, R_{16} = 10\text{k}\Omega, \text{pin } 17$	5.0	5.5	6.0	V
	Muting Drive Output	V_{16-0}	$v_{in} = 0\text{dB}\mu, \text{pin } 16$	4.0	4.8	5.5
	V_{16-100}	$v_{in} = 100\text{dB}\mu, \text{pin } 16$	0	0	0.3	V
AM Rejection Ratio	AMR	$v_{in} = 100\text{dB}\mu, 1\text{kHz tone}, 30\% \text{ AM}$	57	70		dB
Offset Voltage	V_{8-12}	$v_{in} = 0\text{dB}\mu, \text{pins } 8 \text{ to } 12$	-0.25	0	0.25	V
	V_{9-12}	$v_{in} = 0\text{dB}\mu, \text{pins } 9 \text{ to } 12$	-0.5	0	0.5	V
SD Sensitivity	V_{SD}	Pin 19	50	58	66	dB μ
IF Count Output Level	V_{iF-ON}	$v_{in} = 100\text{dB}\mu, \text{pin } 14, C_L = 10\text{pF}$	110	180	280	mVrms
	V_{iF-OFF}	$v_{in} = 100\text{dB}\mu, \text{pin } 14, C_L = 10\text{pF}$		1	3	mVrms

LA1145,1145M

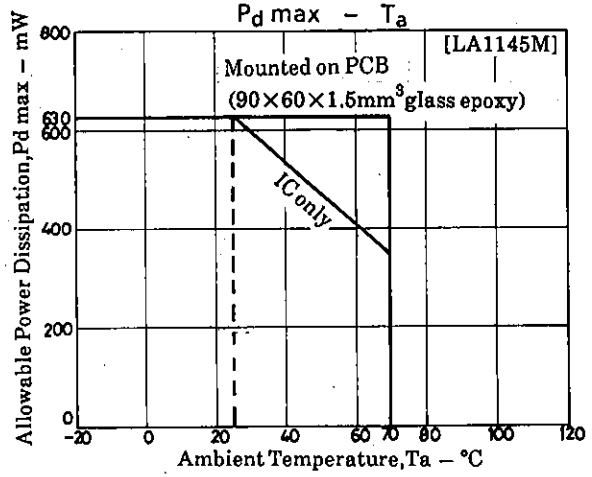
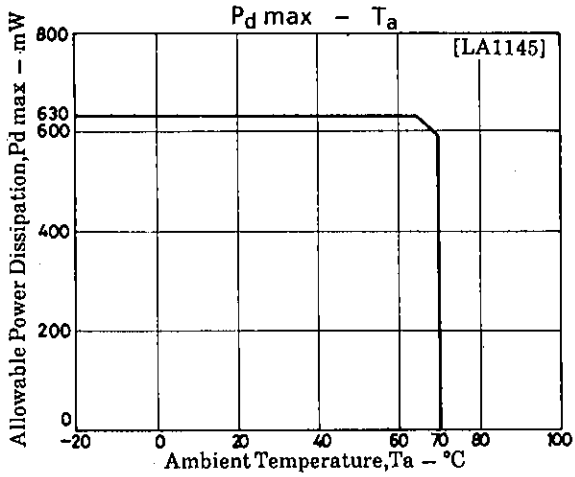

Equivalent Circuit Block Diagram : LA1145

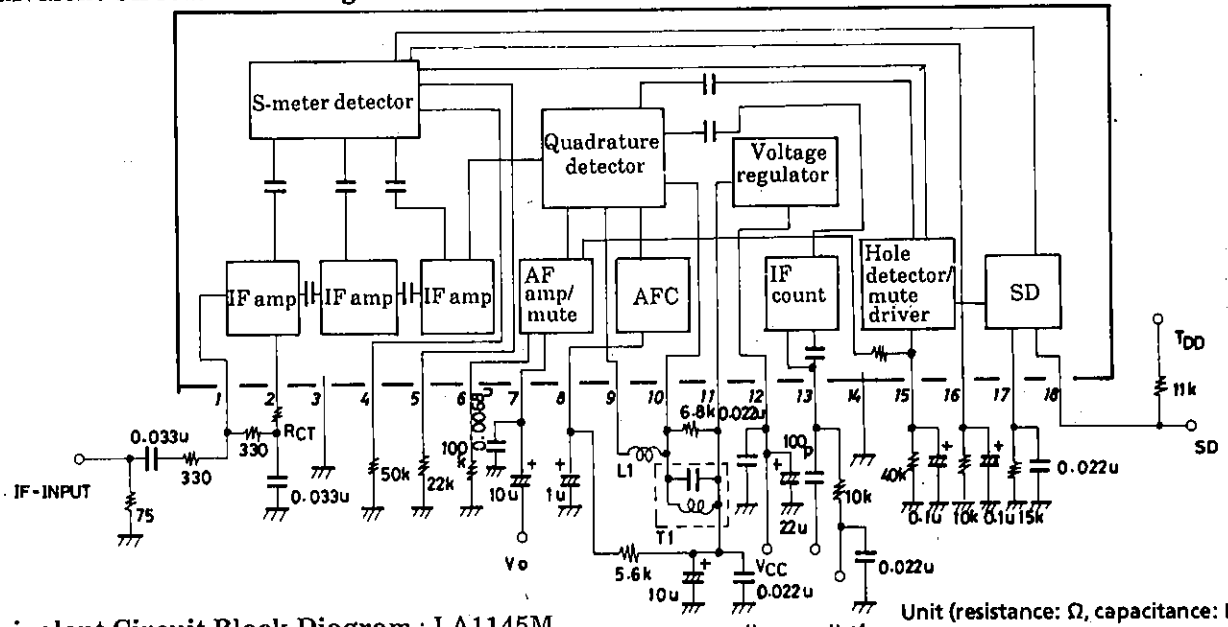

Equivalent Circuit Block Diagram : LA1145M

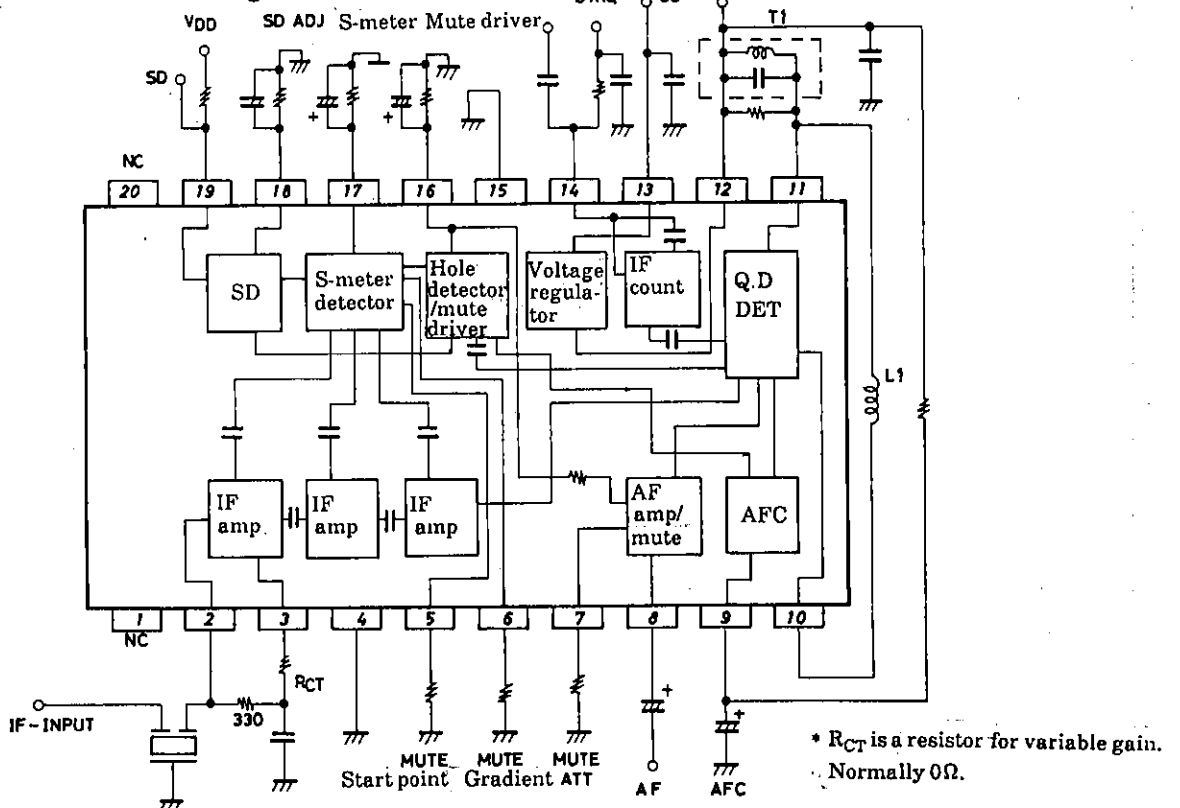

LA1145,1145M

Sample Application Circuit

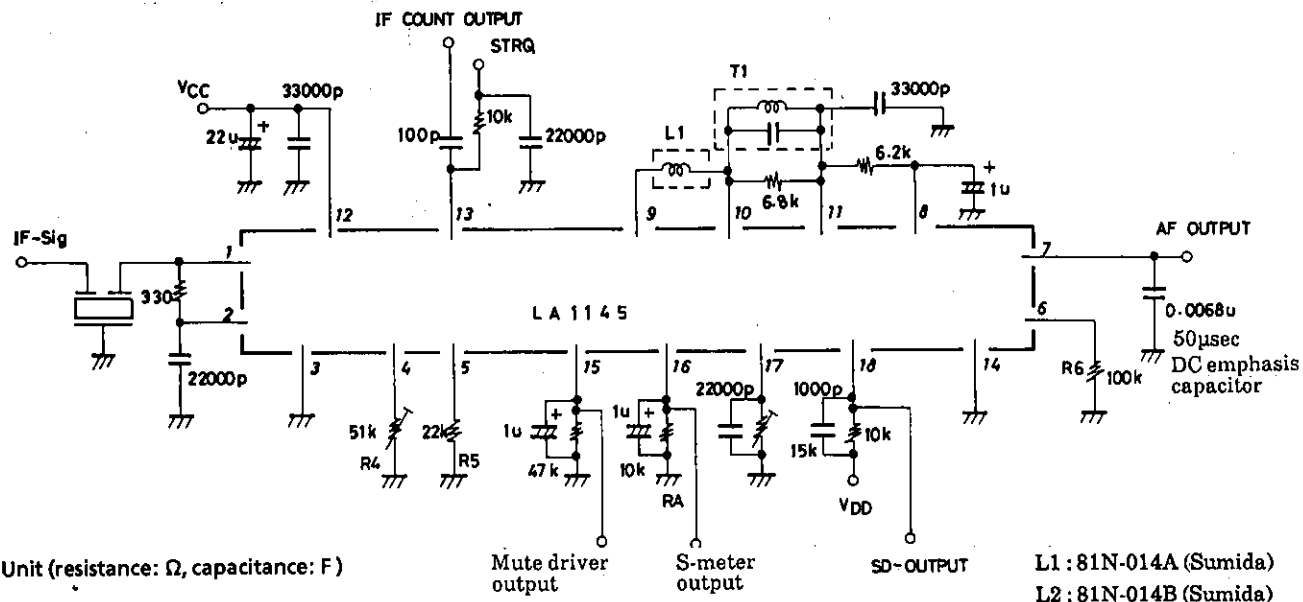

LA1140 and LA1145 Compared

Parameter	LA1140	LA1145	Remarks
Package	SIP-16	SIP-18Z MFP-20	
IF amp, limiter	Direct-coupled	C-coupled	
Quadrature detector	○	○	
AF preamp	○	○	
AFC output	○	○	
Signal meter output	○	◎	Improved linearity, variable S-meter gradient
Band muting	○	◎	Improved temperature stability
IF count buffer output	—	○	Common with STRQ
SD circuit	—	○	For the LA1140, coupled with the soft muting function.
S/N	78dBμ	86dB	
3dBμ limiting sensitivity	25dBμ (fixed)	25 to 40dBμ	— 3dBμ limiting sensitivity variable, independent of soft muting function
Weak signal noise output	○	◎	

LA1145,1145M



LA1145 Pin Description and Typical Voltages

Pin No.	Typical Voltage (V)	Description	Remarks
1	2.6	IF input	
2	2.6	IF amp bias	
3	0.0	IF amp GND	
4	4.0	Mute start control	
5	0.2	Mute gradient control	
6	2.1	Mute attenuation control	
7	4.9	AF output	
8	5.0	AFC output	
9	4.8	IF output	
10	4.8	Quadrature detection input	
11	4.8	Voltage regulator output	
12	8.0	V _{CC}	
13	0.1	IF count output, control	
14	0.0	GND for detection circuit	
15	4.8	Mute driver	
16	0.2	S-meter output	
17	0.2	SD sensitivity control	
18	0.1	SD output	Open collector

LA1145M Pin Description and Typical Voltages

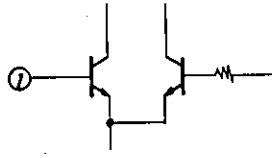
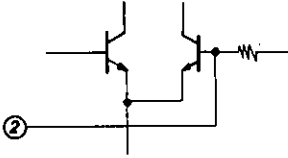

Pin No.	Typical Voltage (V)	Description	Remarks
1	—	NC	
2	2.6	IF input	
3	2.6	IF amp bias	
4	0.0	IF amp GND	
5	4.0	Mute start control	
6	0.2	Mute gradient control	
7	2.1	Mute attenuation control	
8	4.9	AF output	
9	5.0	AFC output	
10	4.8	IF output	
11	4.8	Quadrature detection input	
12	4.8	Voltage regulator output	
13	8.0	V _{CC}	
14	0.1	IF count output, control	
15	0.0	GND for detection circuit	
16	4.8	Mute driver	
17	0.2	S-meter output	
18	0.2	SD sensitivity control	
19	0.1	SD output	Open collector
20	—	NC	

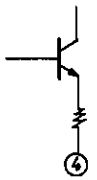
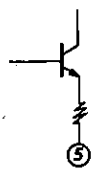
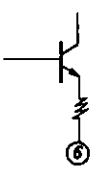
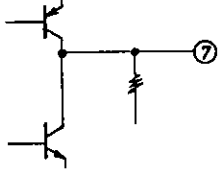
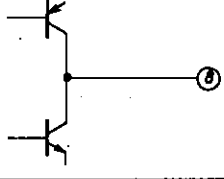
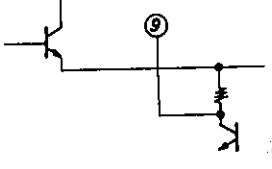
LA1145 Pin Functions (1)

Pin No.	Function	Internal Equivalent Circuit	Notes
1	IF input		
2	Bias pin		
3	GND		IF limiting amp GND
4	Soft mute start point control		For setting the soft mute starting point.
5	Soft muting gradient control pin		Can be used for S-meter output. For setting the mute gradient from the soft mute starting point to the noise finishing point.
6	Mute Att		For setting amount of mute attenuation. The demodulation level changes when the external resistance value is varied.
7	FM-AF output		
8	AFC input		
9	IF output		Output to the phase circuit

LA1145,1145M

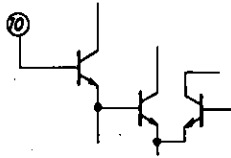
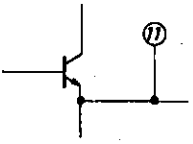
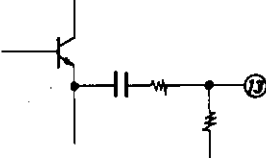
LA1145 Pin Functions (2)

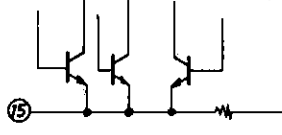
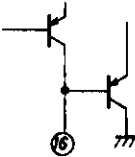
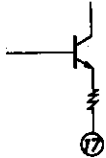
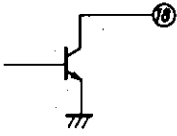
Pin No.	Function	Internal Equivalent Circuit	Notes
10	IF input		IF input via the phase shift circuit. The mute circuit malfunctions and demodulation output decreases if the voltage level at this pin drops below 180mV.
11	Vref		4.8V
12	VCC		Supply voltage 7.5 to 14V
13	IF buffer output		
14	GND		FM detection circuit GND
15	Mute driver		Amount of mute attenuation depends on and is controlled by the voltage at this pin.
16	S-meter output		PNP open collector output
17	SD sensitivity setting		Can be used for S-meter output
18	SD output		High active

SD Output Circuit

1. LA1145 SD output differs from the LA1140's pin substitute SD output as shown below. The SD output on the LA1145 does not operate in conjunction with the soft mute characteristics.

1) LA1140

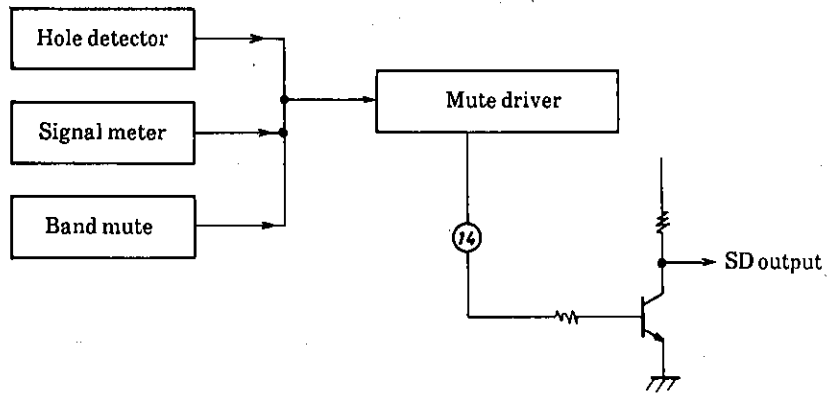

2) LA1145

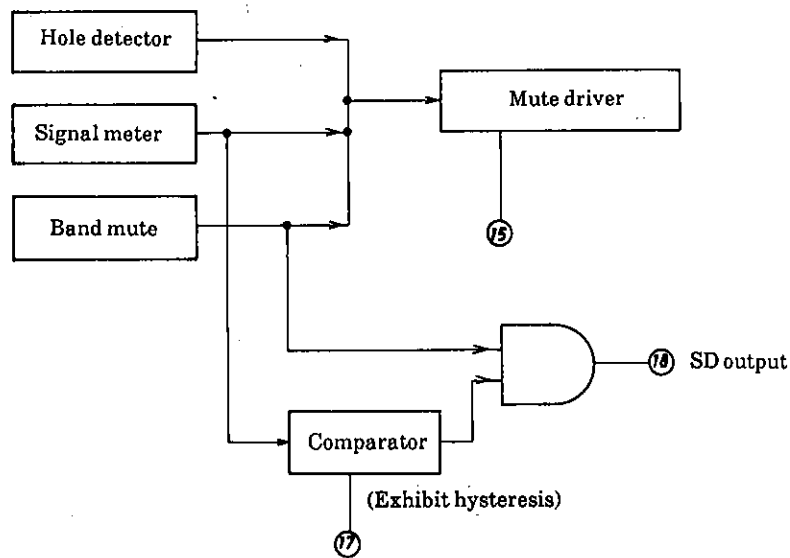

As shown, the SD output is the logical AND of the band mute and S-meter comparator outputs.

2. Signal search using the SD output circuit

2-1 The transition response characteristics of the SD output circuit depends on the time constants of pins 15, 16, 17 and 8.

As the SD output transition response characteristics are determined by the pin with the largest time constant, erroneous stopping will result when a search time is less than the largest one.

2-2 Band mute range circuit time constant (pin 8)

An equivalent circuit to the band circuit is shown below.

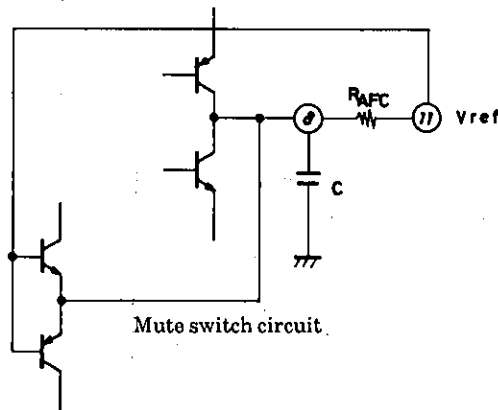

1) Current path during detuning

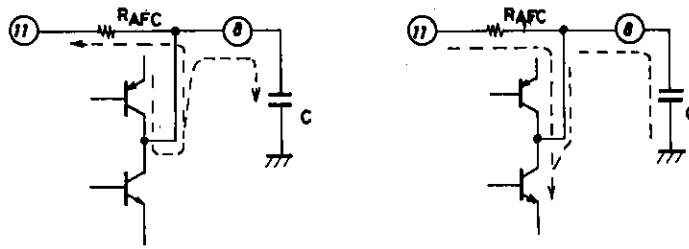

2) Current return path from detuning

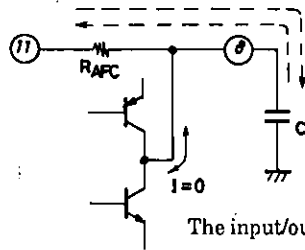

The input/output current from pin 8 becomes zero during return.

As can be seen from the above circuit diagrams, the time constant during detuning is determined by the internal PNP resistance, the NPN collector resistance and the capacitance of the externally-mounted capacitor. This time constant is determined by the external resistance R_{AFC} and capacitor C . This time constant, $\tau = R_{AFC} \times C$, must be set depending on the required search time.

3. Narrow-band SD output circuit

An IF count circuit is provided for equipment compatibility for the European marketplace. However, if the band is made narrow using only the SD circuit, there is a tendency for the number of erroneous stops caused by an undesired signal to increase. To prevent this, two threshold voltages should be used to control the SD circuit.

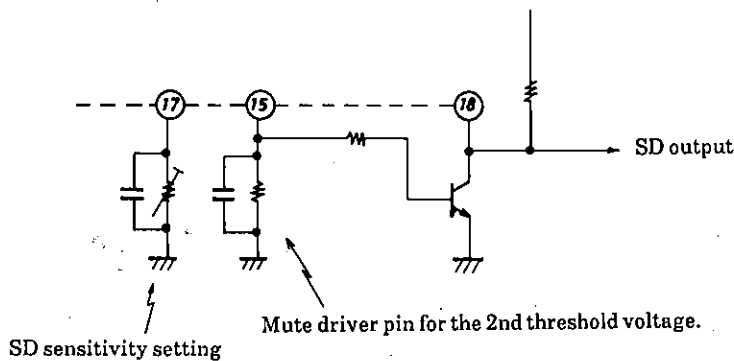

Band Mute Characteristics (1)

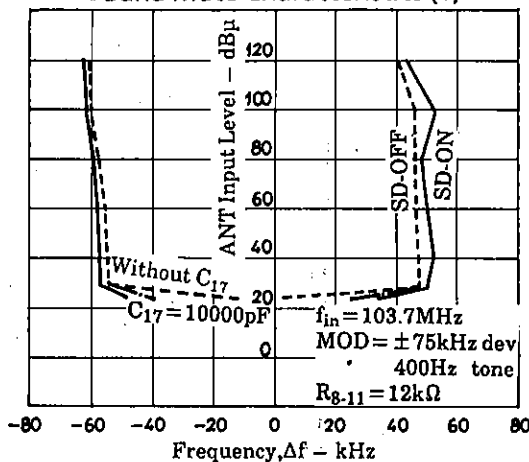

Band Mute Characteristics (2)

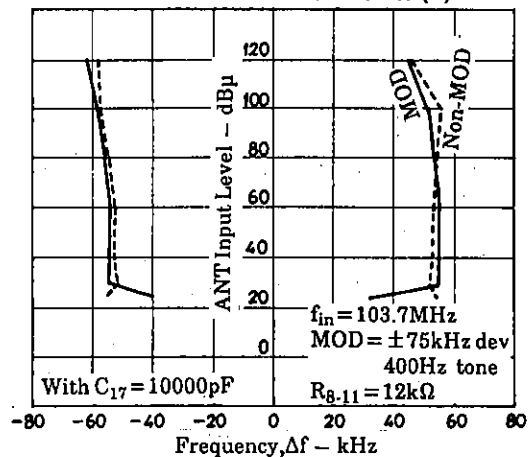

Soft Mute Characteristics

1. Control

The S/N setting (C/N) for weak inputs and the -3dB limiting sensitivity can be controlled by obtaining the proper value for the un-soft muted input/output signal characteristic. However, usable sensitivity cannot be controlled as this is determined by the front end and IF design which are unrelated to soft muting.

2. Soft mute setting

Soft mute operation depends on the S-meter circuit voltage and the hole detection circuit voltage. As shown in the graph on the right, the degree of soft muting correlates with the mute drive voltage, V₁₅. The control signal line of the mute drive voltage switches before and after the 10dB_μ ANT divergence point.

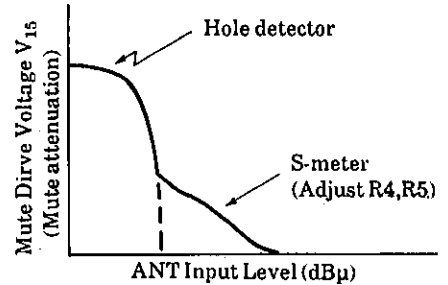

When adjusting the soft mute with a weak signal which does not affect the S-meter, first adjust it using the hole detection input signal. However, as the S-meter output will readjust the soft mute level, also adjust the soft mute using the S-meter output. At this point, the hole detection output adjusts the gain up to the IF input, causing a variance. Also, the S-meter output is varied by the value of R₁₆.

The LA1145 differs from the LA1140 in that it works with the internal soft mute circuit continuously engaged.

3. Soft mute transition response characteristic

The degree of soft muting automatically varies according to the change in input field strength. Omitting the influence of the front end wideband AGC circuit, the LA1145's response speed is dependent on the time constant at pins 15 and 16.

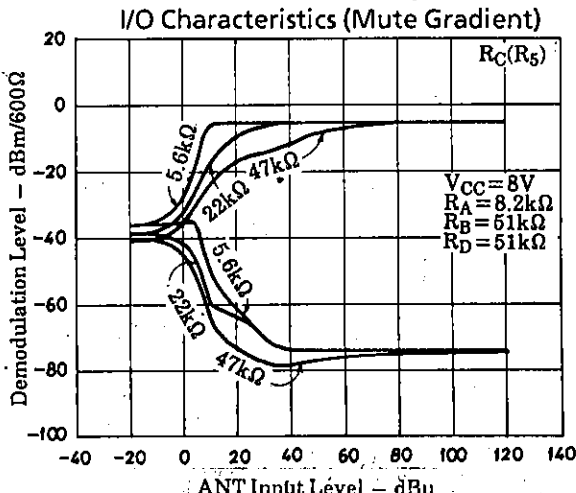
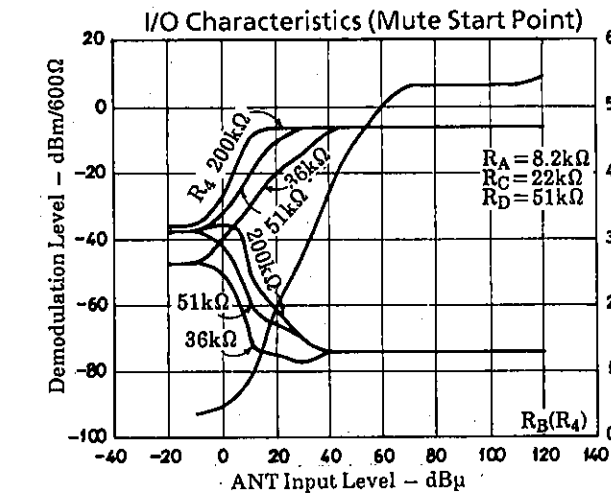
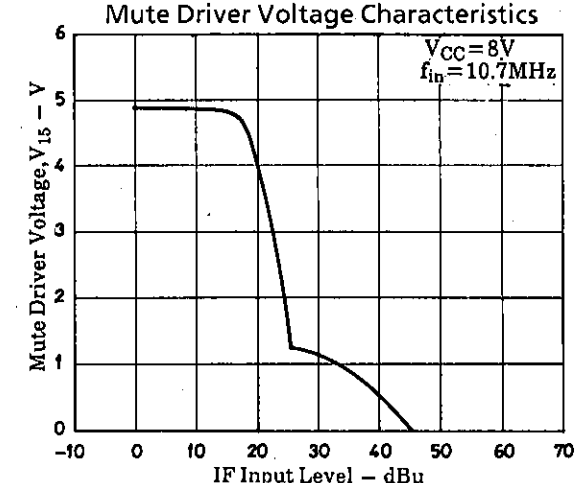
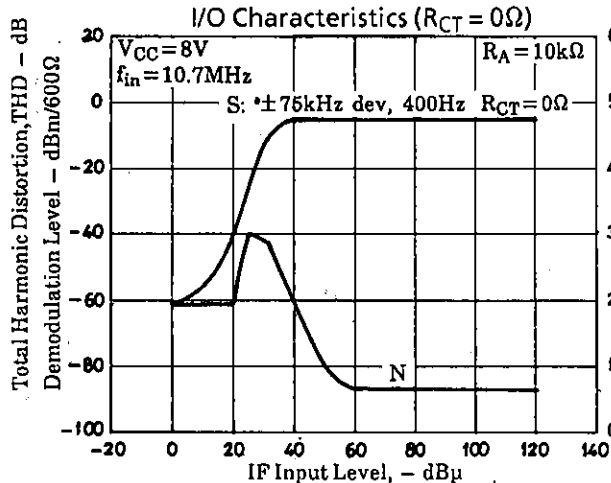

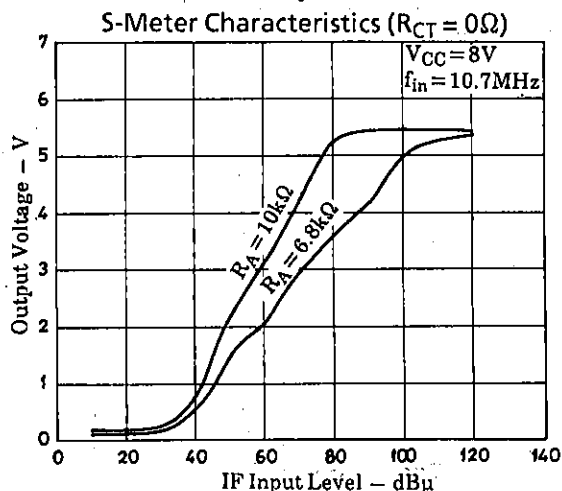
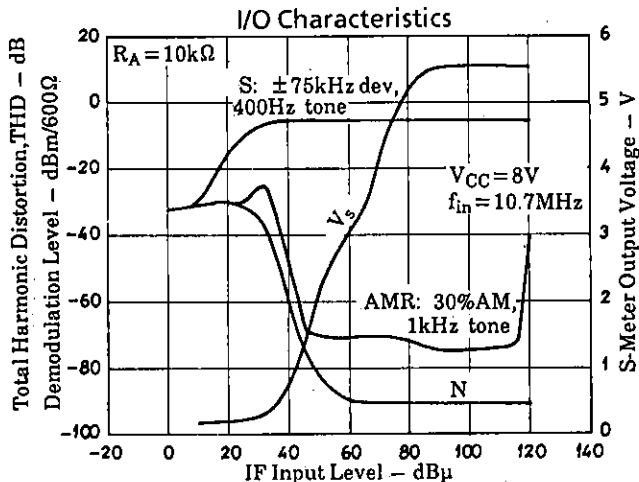
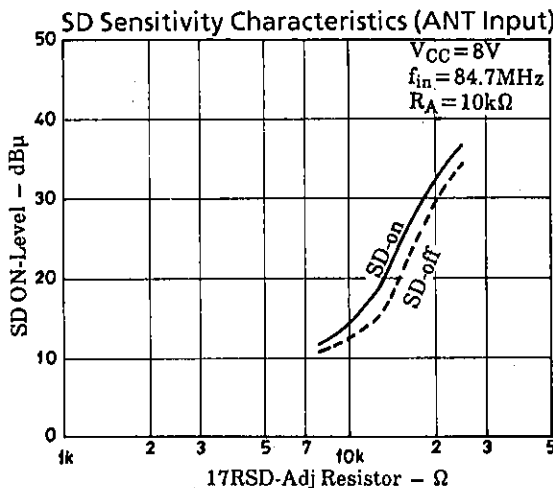
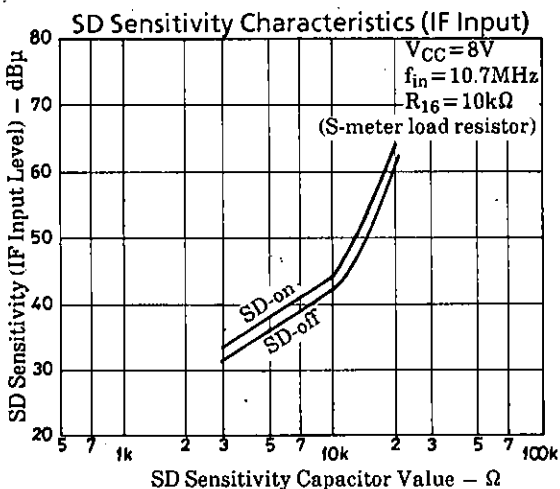
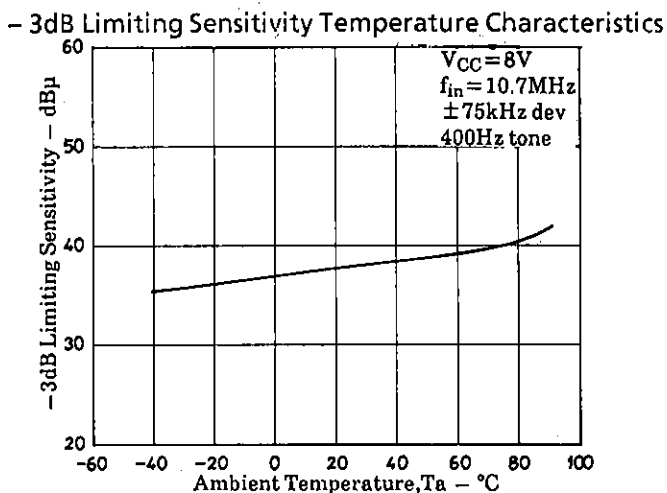
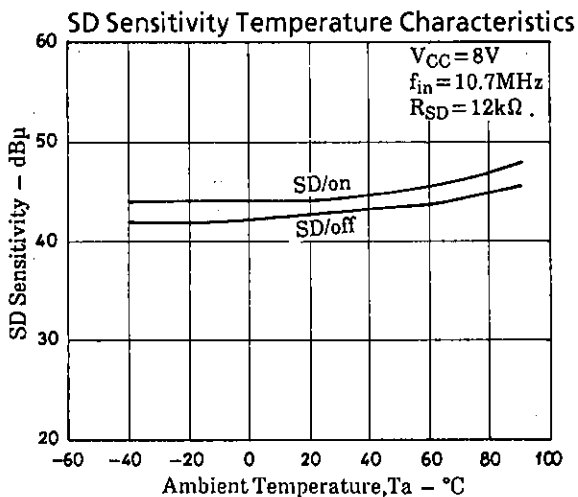
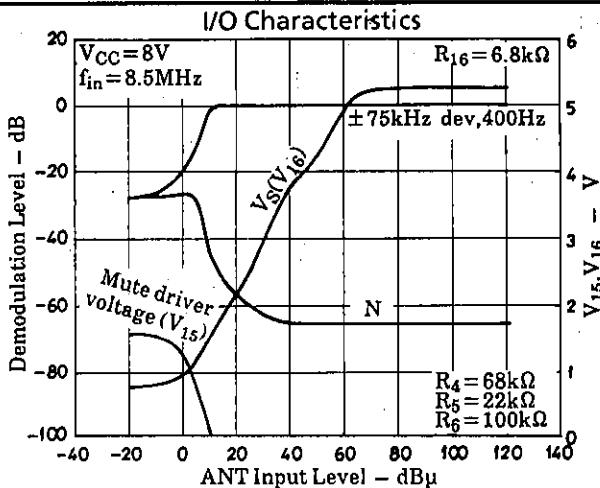
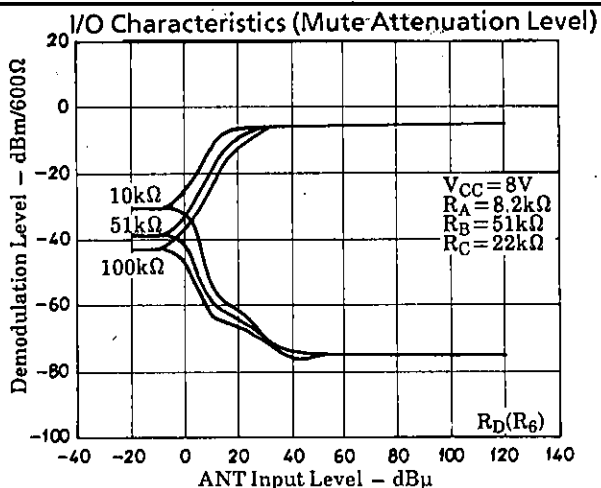

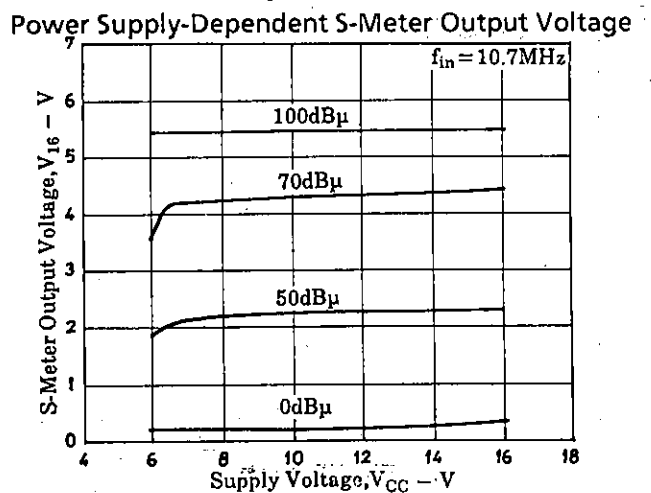
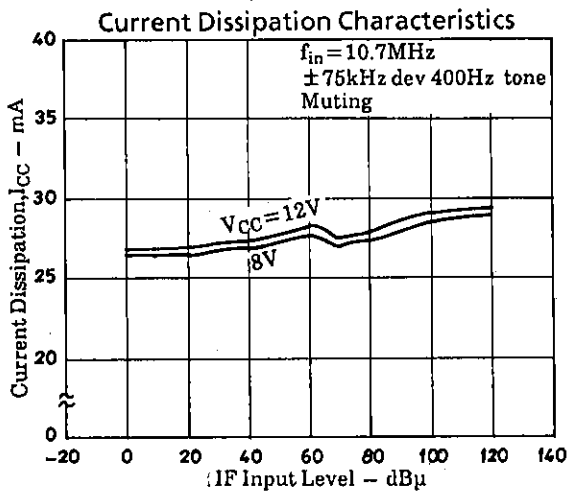
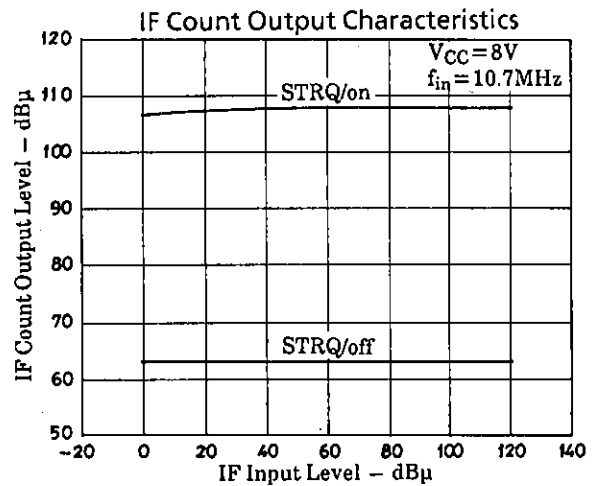
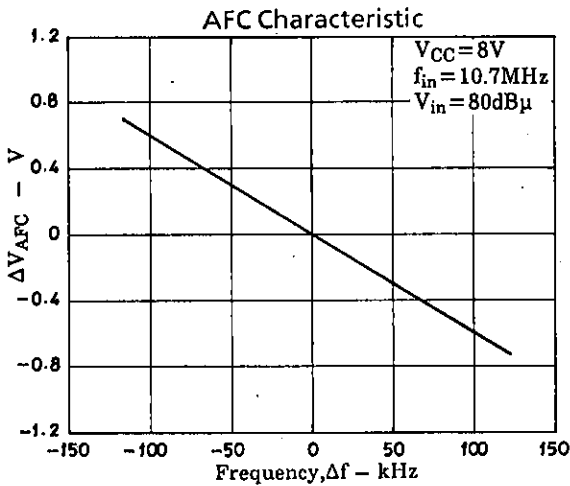
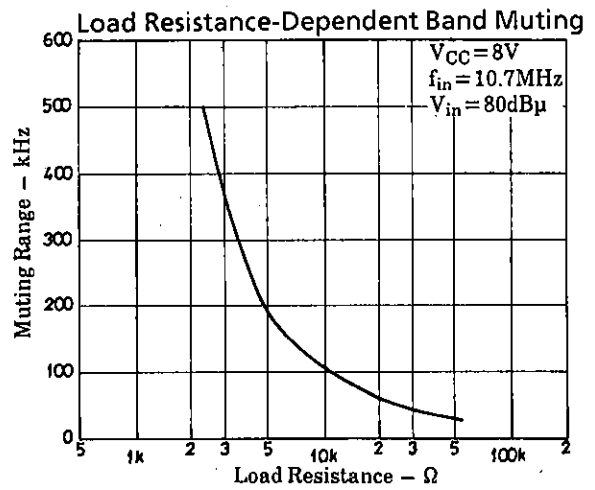
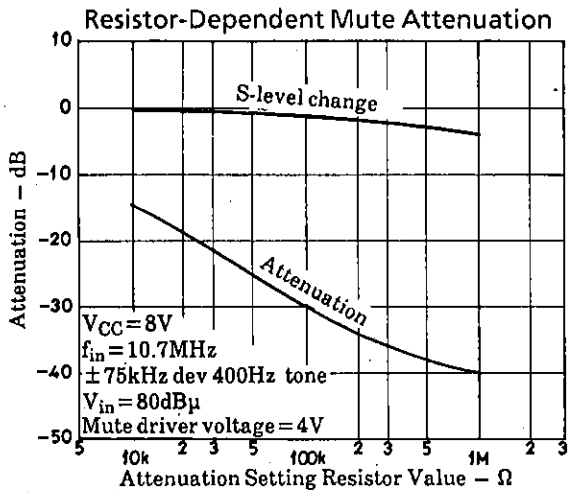
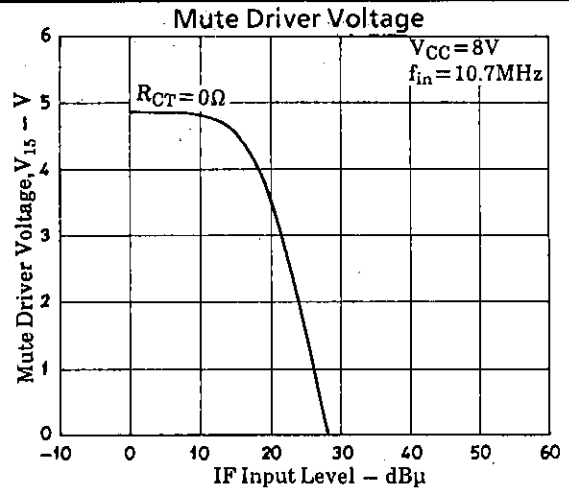
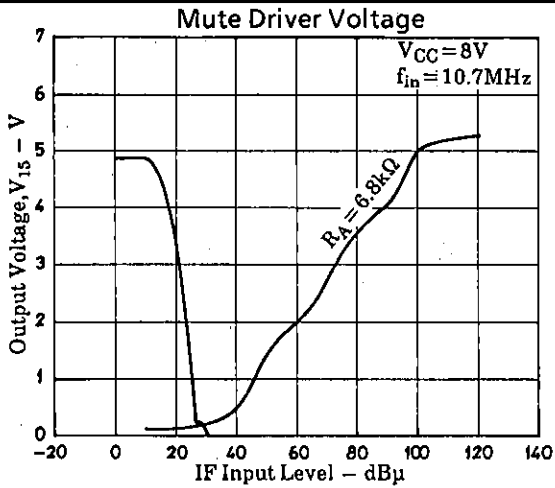

Power Supply-Dependent Demodulation Output

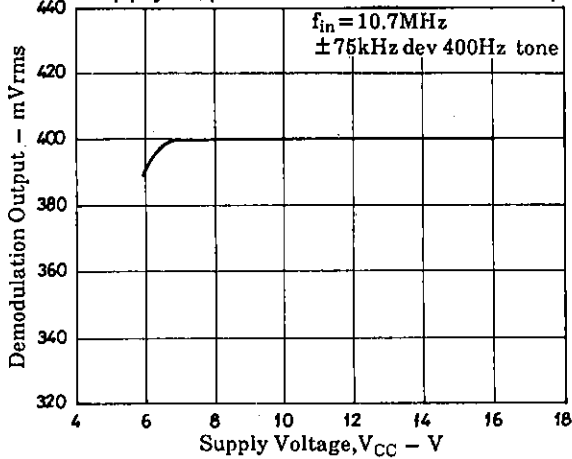

Power Supply-Dependent AMR

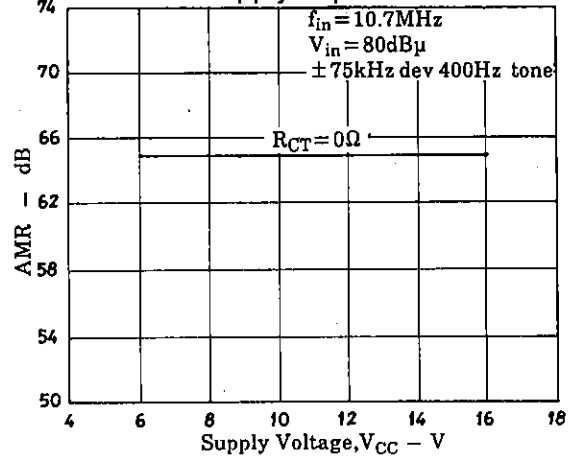

Power Supply-Dependent S/N

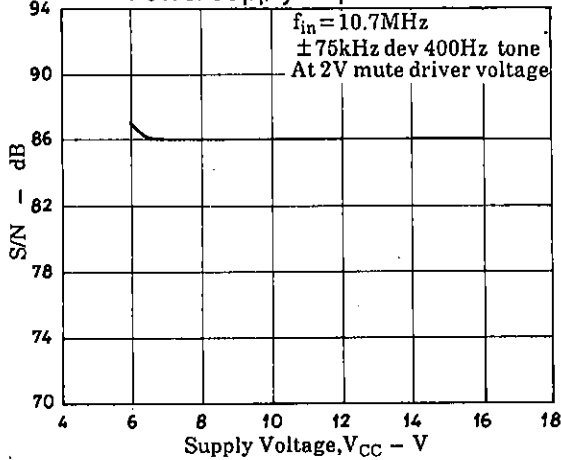

Muting Sensitivity Using Hole Detection Output

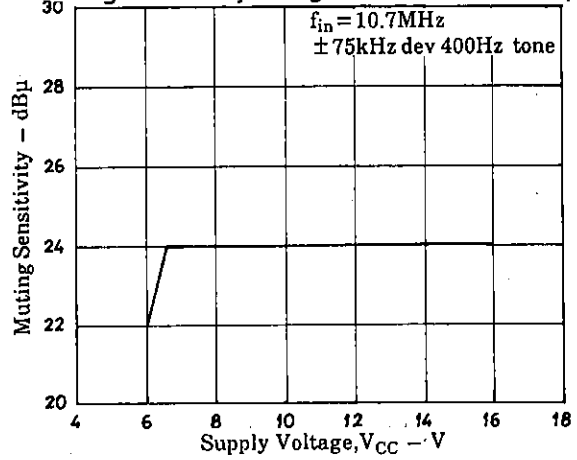

Muting Attenuation Characteristic

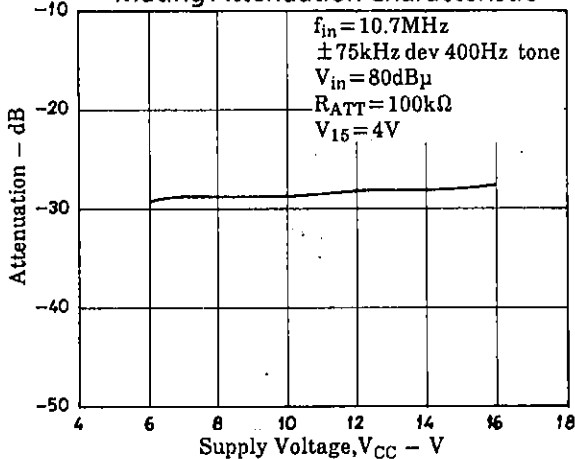

Power Supply-Dependent Mute Driver Voltage

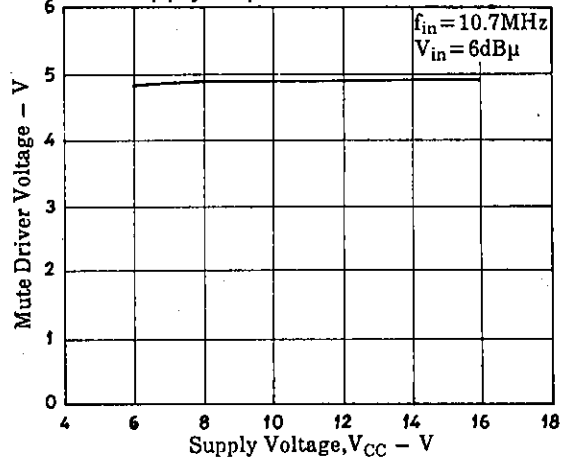

Power Supply-Dependent Muting Bandwidth

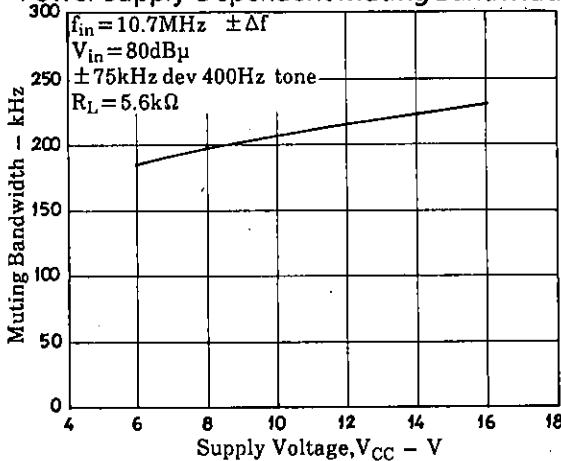

Tuning Point Shift

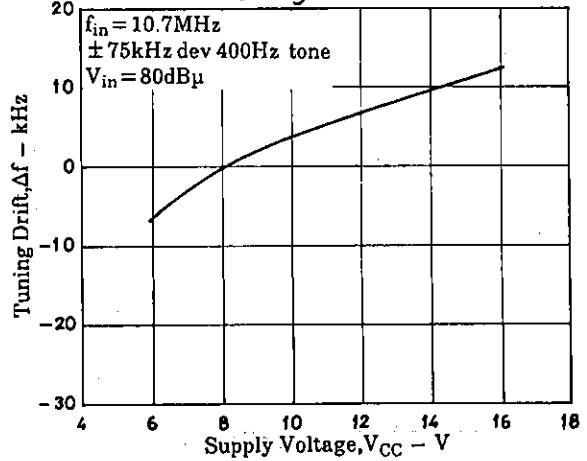

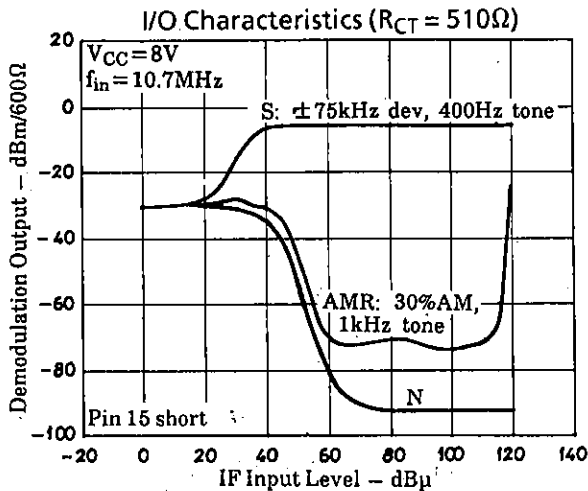
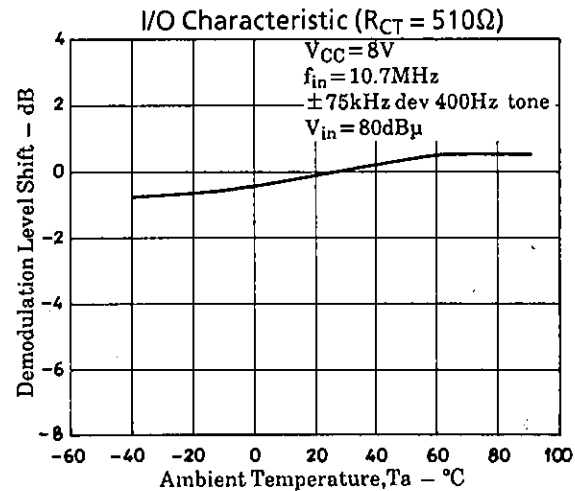
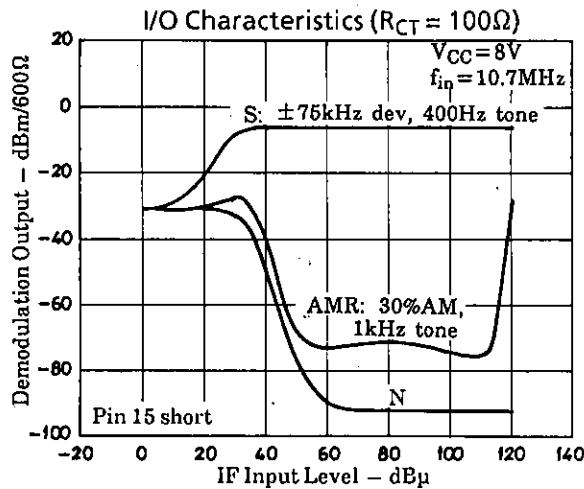
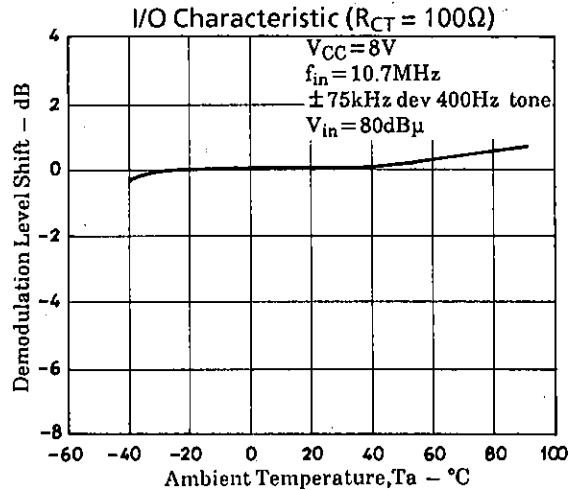
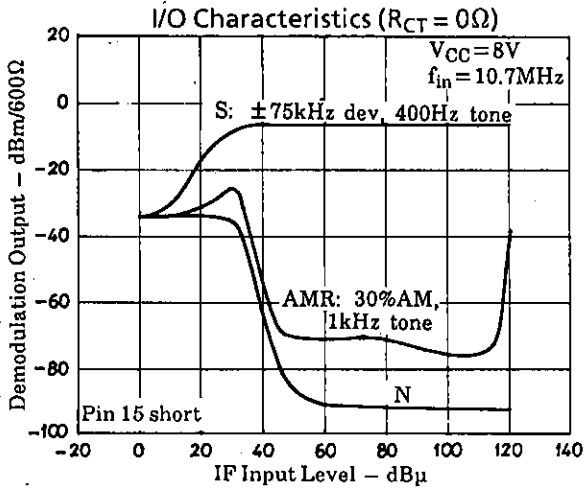
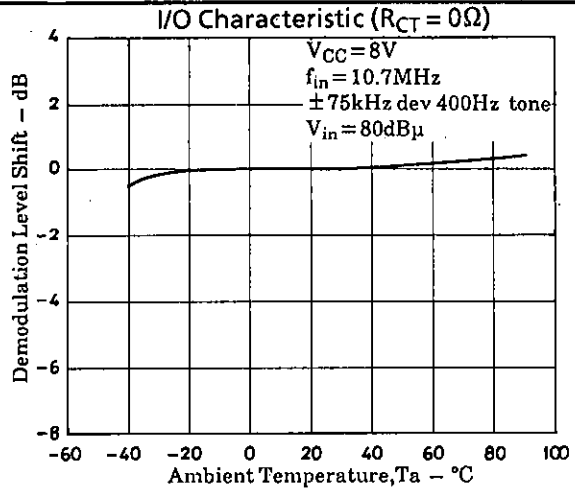
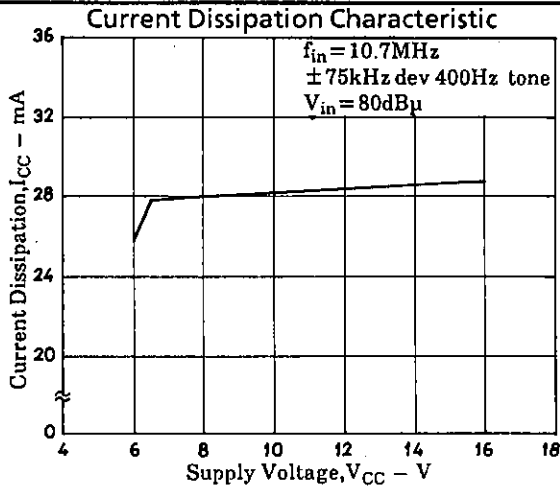

S-Meter Characteristic (Temperature Characteristic)

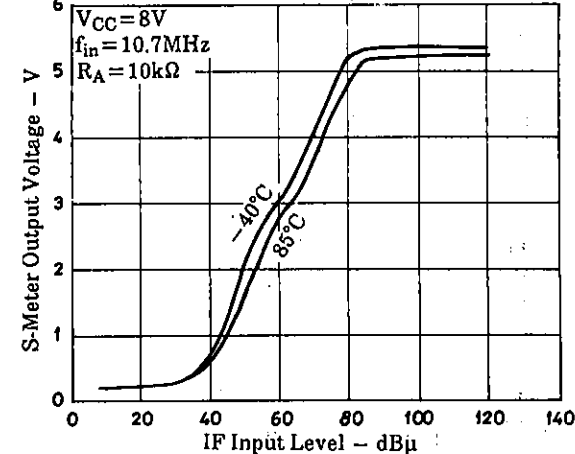

-3dB Limiting Sensitivity Temperature Characteristic

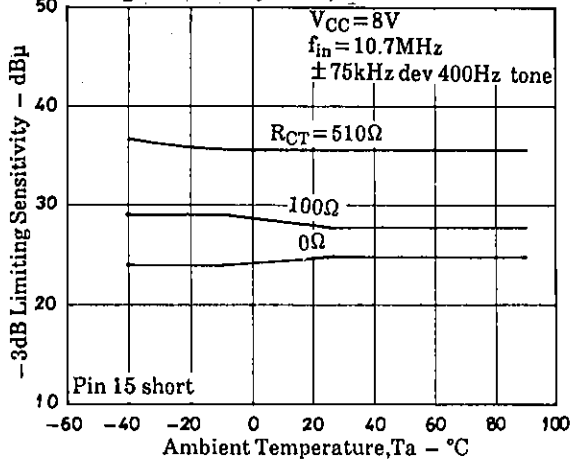

Muting Attenuation Characteristic

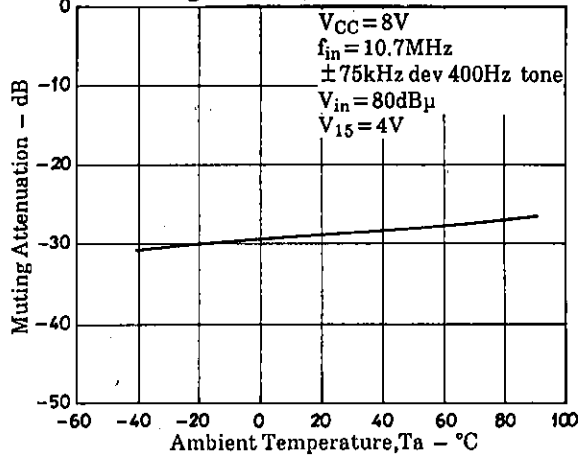

Muting Bandwidth Temperature Characteristics

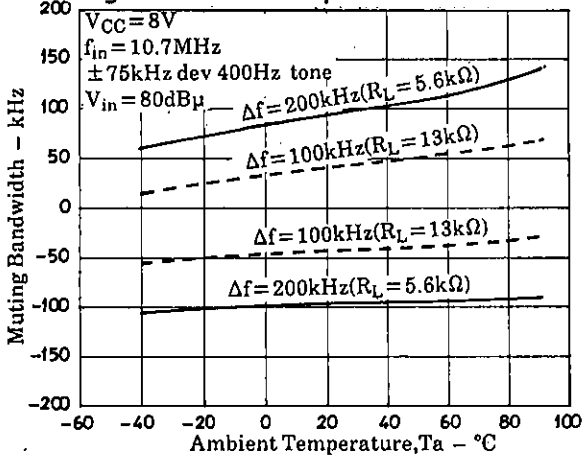

AMR Temperature Characteristic

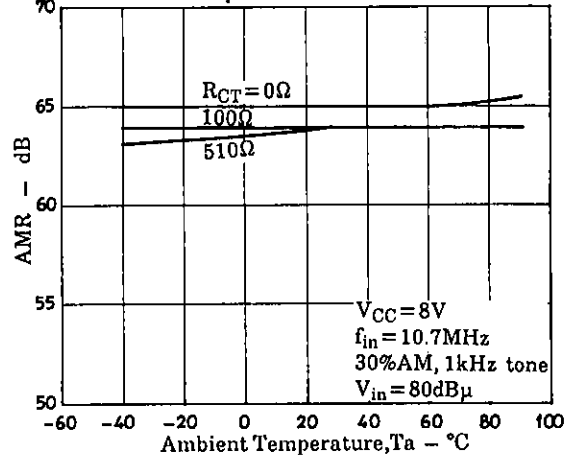

IF Count Output Level Shift

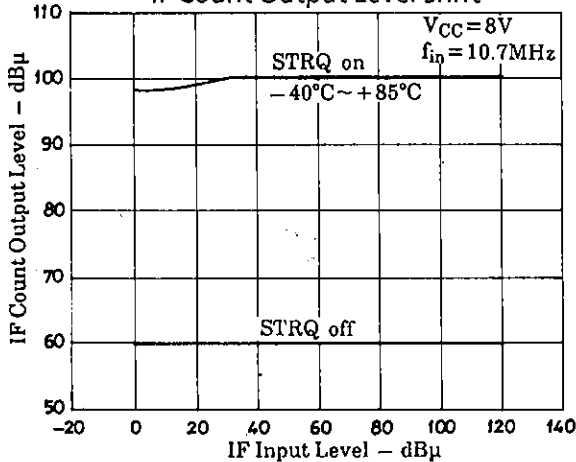

THD Characteristic (Single Tuning Circuit)

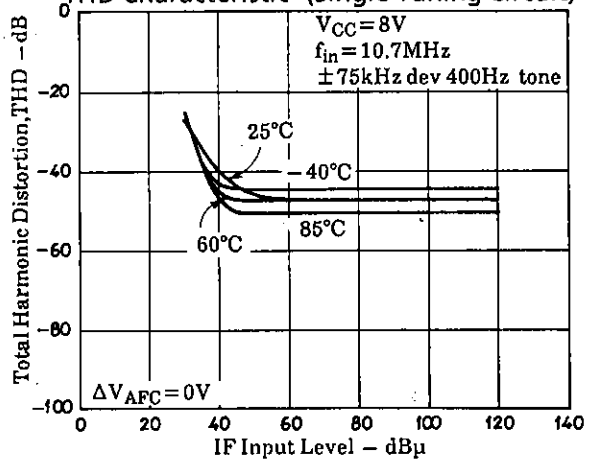

THD Detuning Characteristics

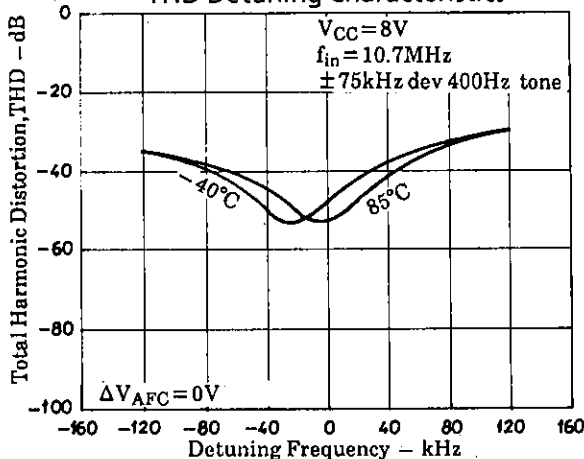

- No products described or contained herein are intended for use in surgical implants, life-support systems, aerospace equipment, nuclear power control systems, vehicles, disaster/crime-prevention equipment and the like, the failure of which may directly or indirectly cause injury, death or property loss.
- Anyone purchasing any products described or contained herein for an above-mentioned use shall:
 - ① Accept full responsibility and indemnify and defend SANYO ELECTRIC CO., LTD., its affiliates, subsidiaries and distributors and all their officers and employees, jointly and severally, against any and all claims and litigation and all damages, cost and expenses associated with such use:
 - ② Not impose any responsibility for any fault or negligence which may be cited in any such claim or litigation on SANYO ELECTRIC CO., LTD., its affiliates, subsidiaries and distributors or any of their officers and employees jointly or severally.
- Information (including circuit diagrams and circuit parameters) herein is for example only; it is not guaranteed for volume production. SANYO believes information herein is accurate and reliable, but no guarantees are made or implied regarding its use or any infringements of intellectual property rights or other rights of third parties.