

SANYO**FM IF System Applications****Overview**

The LA1235 is a high integrated IC developed for use in high S/N, low distortion FM IF system applications. This IC features S/N=88dB, distortion factor=0.015% and has almost all functions required for FM tuner IF stage.

The IF amplifier and limiter stage consist of 6 stages of double ended differential amplifier having an excellent AMR, and this stage is followed by the signal meter driver which consists of 4 stages of level detector, thereby creating extended linearity up to strong input. The FM detector stage consists of a double balanced quadrature detector to which a low frequency preamplifier and a muting controller are attached. The muting drive stage consists of an OR circuit for weak signal muting drive output which detects signal intensity and detuning muting drive output which detects S curve DC output and enables the prevention of noise at the time of weak signal and detuning. Further, the weak signal muting drive output circuit contains a Schmitt circuit having hysteresis and enables the prevention of muting malfunction due to amplitude component at the time of weak signal. The AFC output and tuning meter drive stage is of current drive type which makes it possible to adjust AFC sensitivity and muting band width by means of an external resistor, and the built-in tuning meter null (short) circuit forces the tuning meter to be [0] when the IF amplifier stops working. The IF amplifier stop circuit, being a circuit to stop the FM IF amplifier at the time of AM reception, makes it possible to decrease shock noise due to FM-AM receiving mode switchover.

Package Dimensions

unit: mm

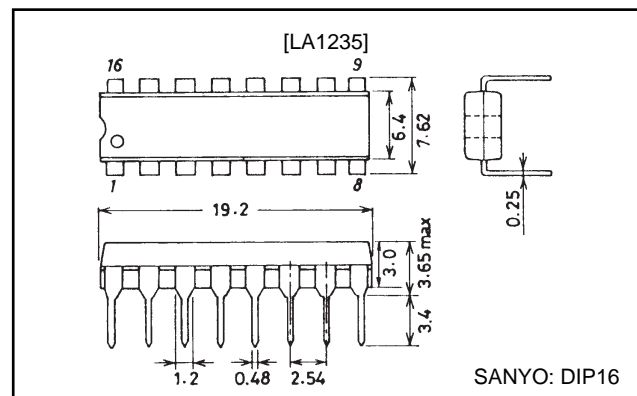
3006B-DIP16**Functions**

- IF amplifier, Limiter.
- Quadrature detection.
- AF preamplifier.
- Signal intensity muting drive output.
- Detuning muting drive output.
- AF signal muting circuit.
- Signal meter drive output.
- AFC, tuning meter drive output.
- IF amplifier stop circuit.
- Tuning meter null circuit.

Features

- High S/N (88dB typ.).
- Low distortion (0.015% typ.).
- Weak signal muting drive output having hysteresis.
- Tuning meter null (short) circuit.
- Signal meter drive output having wide dynamic range.
- High limiting sensitivity.
- Built-in constant-voltage regulated circuit (Operating voltage : 10 to 14V).

LA1235

Specifications

Maximum Ratings at Ta=25°C

Parameter	Symbol	Conditions	Ratings	Unit
Maximum supply voltage	V _{CCmax}	Pin 11	16	V
Input voltage	V _{IN}	Pins 1 to 2	±1	Vp-p
Supply current	I _{CC}	Pin 11	40	mA
Flow-in current	I ₅	Pin 5	3	mA
Flow-out current	I ₁₀	Pin 10	2	mA
	I ₁₃		2	mA
Allowable power dissipation	Pd max		650	mW
Operating temperature	T _{opr}		-20 to +70	°C
Storage temperature	T _{stg}		-40 to +125	°C

Recommended Operating Conditions at Ta=25°C

Parameter	Symbol	Conditions	Ratings	Unit
Recommended supply voltage	V _{CC}		10 to 14	V

Operating Characteristics at Ta=25°C, V_{CC}=12V, f=10.7MHz

Parameter	Symbol	Conditions	Ratings			Unit
			min	typ	max	
Quiescent current	I _{CCO}	Quiescent		21	30	mA
Current drain	I _{CC}	V _{IN} =100dBμ		22	31	mA
Detection output	V _O	V _{IN} =100dBμ, 400Hz, 100% mod.	310	430	590	mVrms
S/N		V _{IN} =100dBμ, 400Hz, 100% mod.	82	88		dB
-3dB limiting sensitivity	V _{IN(lim)}	V _O : -3dB, 400Hz, 100% mod.		25	31	dBμ
Muting sensitivity	V _{IN(mute)}	V ₁₂ =5.6V, R ₁₆ =56kΩ, R ₁₅ =50kΩ		40	50	dBμ
Muting attenuation	mute(att)	V _{IN} =100dBμ, 400Hz, 100% mod. V ₅ =3.5V	80	100		dB
Muting bandwidth	BW(mute)	V _{IN} =100dBμ, V ₁₂ =3V	120	200	330	kHz
Muting driving output	V ₁₂₍₁₎	Quiescent	5.6	6.2	6.8	V
	V ₁₂₍₂₎	V _{IN} =100dBμ		0	0.3	V
Total harmonic distortion	THD	V _{IN} =100dBμ, 400Hz, 100% mod.		0.015	0.05	%
AM suppression ratio	AMR	V _{IN} =80dBμ, FM =400Hz, 100% mod, AM =1kHz, 30% mod.	45	60		dB
Signal meter driving output	V ₁₃₍₁₎	Quiescent		0	0.1	V
	V ₁₃₍₂₎	V _{IN} =35dBμ		0.1	0.5	V
	V ₁₃₍₃₎	V _{IN} =70dBμ	1.3	2.0	2.9	V
	V ₁₃₍₄₎	V _{IN} =100dBμ	2.2	3.5	5.0	V
Offset voltage	V ₆₋₁₀	Quiescent, pin 6 to 10	-0.8	0	+0.8	V
	V ₇₋₁₀	Quiescent, pin 7 to 10	-0.4	0	+0.4	V
Tuning meter null voltage	V _{7-10(null)}	V ₅ =7.5V, pin 7 to 10	-50	+5	+50	mV
IF-off voltage	I _{15(IF off)}	V ₂₋₃ =1V	5.6		7.5	V

Reference Pin Voltage

Pin No.	Condition	Pin voltage (V)
V ₁		2.6
V ₂		
V ₃		
V ₆		6.2
V ₇		
V ₈	Quiescent	5.9
V ₁₀		6.2
V ₁₂		
V ₁₃		0
V ₁₅		
V ₁₆		

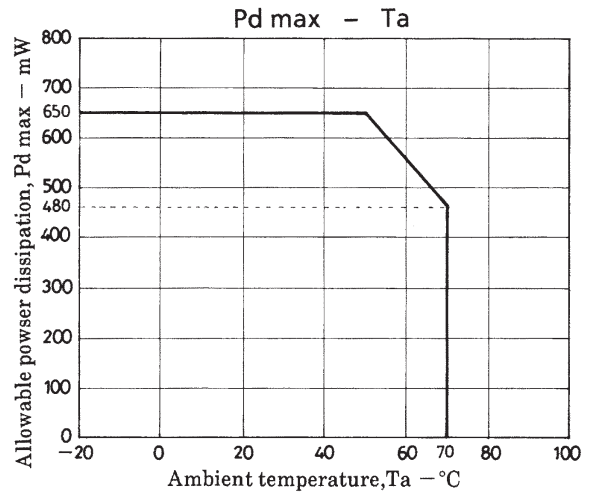

Test Circuit

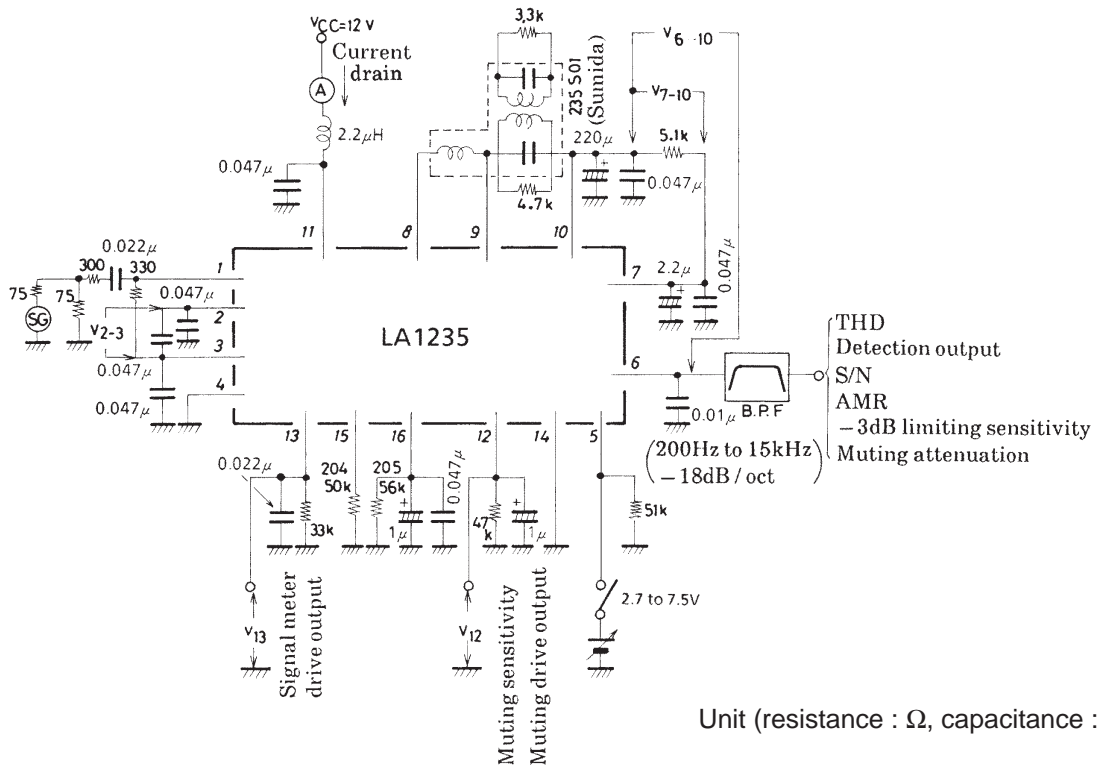

• Setting of muting sensitivity, hysteresis width (Refer to the equivalent circuit block diagram and application circuit). Muting sensitivity and hysteresis width are set arbitrarily by varying resistors R₂₀₄ and R₂₀₅ connected to pins 15 and 16, respectively. Muting sensitivity is set by varying R₂₀₄ ; and if R₂₀₄ is made larger, muting sensitivity will shift to the weak signal side. Hysteresis width is set by varying R₂₀₅ ; and if R₂₀₅ is made larger, hysteresis width will narrow. Next, how to set muting sensitivity is concretely described as follows. In case of using R₂₀₄=50kΩ (semifixed resistor) and R₂₀₅=56kΩ, the upper limit of current I₁₆, 50μA, delivered from the signal meter driver at which muting is turned ON is obtained from the first quadrant of Table for muting adjustable lower limit calculation. Muting is turned ON at I₁₆≤50μA. If I₁₆≤50μA, muting is already turned ON at a point of input being stronger than the setting input and it is impossible to adjust muting at the setting input. Therefore, I₁₆>50μA is required at the setting input. The input at which a sample with a small I₁₆ output meets 50μA is obtained as V_{IN}=47dBμ. This input is the maximum value of muting sensitivity, that is to say, the lower limit at with muting can be set. The data for sample with a Small I₁₆ shown in this Table is colose to the minimum value, but since samples with values less than this munimum value may occur, a margin of some dBμ must be allowed. From the above, the minimum value for muting setting (muting ON input) becomes 50dBμ for R₂₀₄ (semifixed resistor)=50kΩ and R₂₀₅=56kΩ.

Muting sensitivity setting by means of R₂₀₄

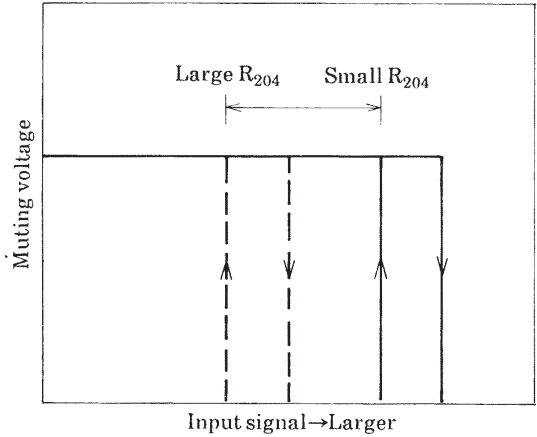

Hysteresis width setting by means of R₂₀₅

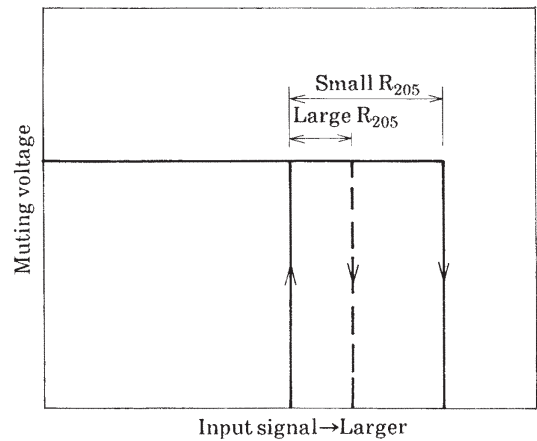
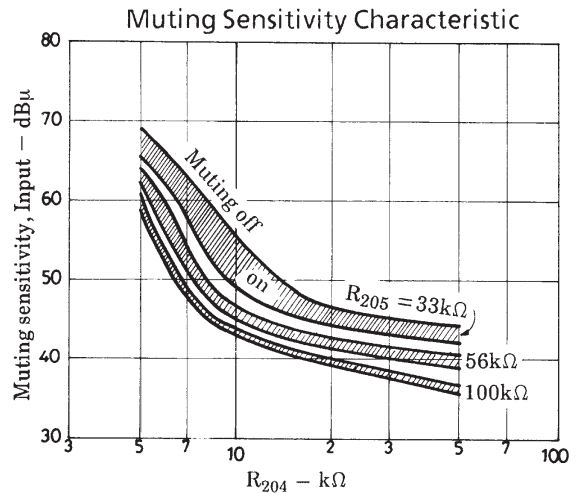
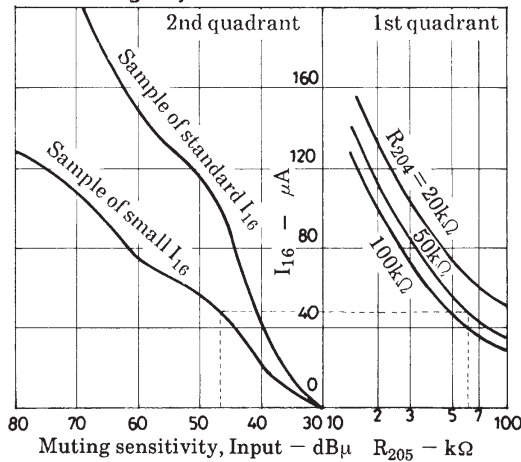

Table for muting adjustable lower limit calculation



LA1235

- Setting of muting circuit constants

Drive current to be output at muting drive output pin 12 is 0.75mA typ., but approximately 0.4mA may be caused by variations in characteristic or changes in temperature (smaller at higher temperatures). It is desirable to design the circuit so that the total current to be output from pin 12 at the time of muting ON does not exceed 0.35mA. When driving the muting circuit of the LA1235, the muting drive current (input current at pin 5) must be considered besides this total output current. The muting drive current of the LA1235 is 0.2mA max.

Thus, the muting constants are obtained as follows. If the muting drive current is $I_{R207} \geq 0.2\text{mA}$, $R_{207} \leq 14\text{k}\Omega$ occurs and the total current I_t is shown by the following expression.

$$I_t = I_{R206} + I_{R207} = \frac{6.2\text{V}}{R_{206}} + \frac{4.8\text{V}}{R_{206} + 10\text{k}\Omega} \quad (10\text{k}\Omega : \text{Input resistance at pin 5, Refer to the above figure.})$$

If $R_{207} = 10\text{k}\Omega$ is taken with the variations in voltage V_{12} at pin 12 and input resistance $10\text{k}\Omega$ at pin 5 considered, $R_{206} \approx 56.4\text{k}\Omega$ is obtained, and then $R_{206} = 68\text{k}\Omega$ and $R_{207} = 10\text{k}\Omega$ are obtained.

- Setting of C_{112} (Capacitance between pin 12 and ground)

C_{112} influences S/N and muting attenuation. S/N is improved 0.5 to 2.0dB by changing C_{112} from $1\mu\text{F}$ to $100\mu\text{F}$. Muting attenuation becomes as shown in Mute (att) - fm (next page) characteristic. This phenomenon occurs because the output at pin 7 appears at pin 6 through pin 10 and capacitance C_{110} between pin 7 and ground also exerts influence. The relation between muting attenuation and C_{110} is such that if $C_{110} = 2.2\mu\text{F}$ and $C_{112} = 220\mu\text{F}$, attenuation at modulation frequency 100Hz becomes -80dB .

Muting Circuit

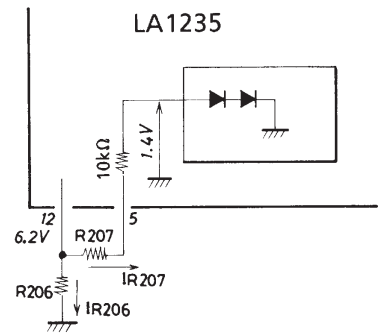

AF Output Circuit

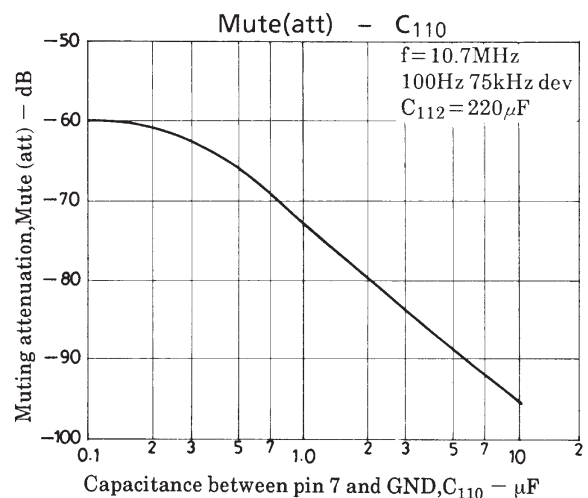
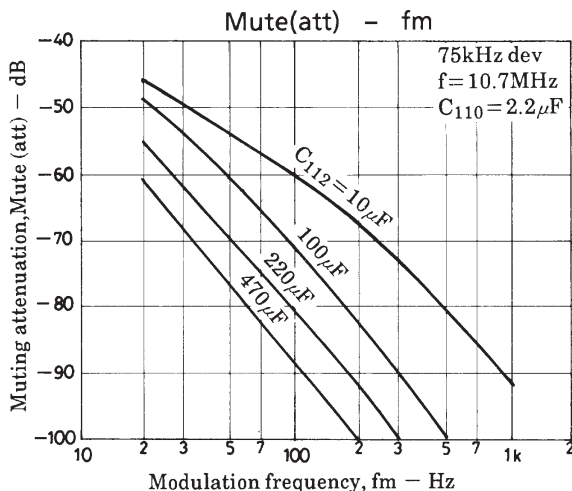
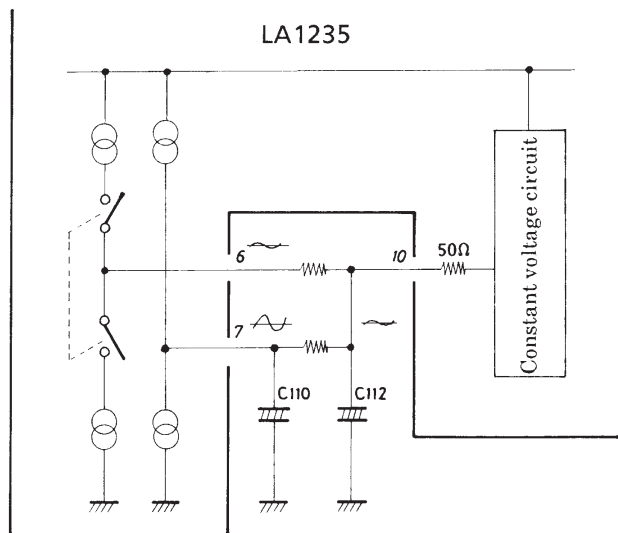

Description of external parts

Part No.	Function	Effect	
		If decreased	If increased
R201	Input resistance (Rg)	Causes matching wigh circuit of preceding stage.	
R202 R203	S meter adjust	Current drain increases. (Observe max. rating).	S meter pointer is off zero point. (In case of voltage drive type).
R204	Muting sensitivity adjust	Muting sensitivity shifts to weak input side.	
R205	Hysterisis adjunt	Large hysteresis.	Small hysteresis.
R206	Muting drive circuit load	Insufficient drive of detuning muting.	When driveing muting of LA3390 (MPX), make less than 200kΩ to prevent malfunction.
R207	Muting time constant	Abnormal detuning muting attenuation waveform and abnormal sound at the time of low frequency modulation.	Muting response delay.
R208	IF-off voltage applying resistnace	Large flow-in current at pin 5 (Observe max. rating).	IF-off does not occur. (IF-off voltage≥7.5V).
R209 R210	AFC, detuning muting band width, tuning meter deflection adjust	Large detuning muting bandwidth.	Small detuning muting bandwidth.
R211	Detection coil damping	Small detection output.	Large detection output.
R212	S curve linearity correction	Find such a value as to cause minimum distortion (THD).	
C101 C102 C103	IF amplifier bypass	Unstable IF amplifier.	
C104	S meter output bypass	IF system may be unstable.	
C105 C106	Muting drive output bypass	If low frequency AM compoent is generated in IF signal, weak signal muting flutters.	Muting response delay.
C107 C108	Muting drive output smooth	Abnormal detuning muting attenuation waveform and abnormal sound at the time of low frequency modulation.	Muting response delay.
C109	AF output LPF	Unstable IF system.	With MPX connected, separation worsens.
C110	AFC output LPF	Muting attenuation worsens and detuning muting bandwidth narrows.	Detunig muting response delay.
C111 C112	Constant voltage circuit smooth	S/N, muting attenuation worsen.	
C113	Power supply bypass	Unstable IF system.	
L1	Power supply choke	Unstable IF system.	

Proper cares in using IC

- Connect the ground side of bypass capacitors of pins 2, 3 to an area close to pin 4.
- Connect the ground side of bypass capacitors of pins 6, 7, 10, 13, 16 to an area close to pin 14.
- Use the shortest possible wires for detection coil-to-pins 8, 9, 10 connection.
- Pin 13, being used for signal meter drive output, can be also used multipath detection because IF signal envelope detected is output at this pin.

Coil specifications

Supplier	Coil name	Damping resistance		Remarks
		R211	R212	
Sumida	235S01	4.7kΩ	3.3kΩ	Containing fixed inductance 26μF. Containing fixed inductance 26μF. (Improvement in temperature characteristic).
	SNY-074-1919A	7.5kΩ	2.4kΩ	
Toko	Q228CEL-1077B	13kΩ	3.0kΩ	Containing fixed inductance

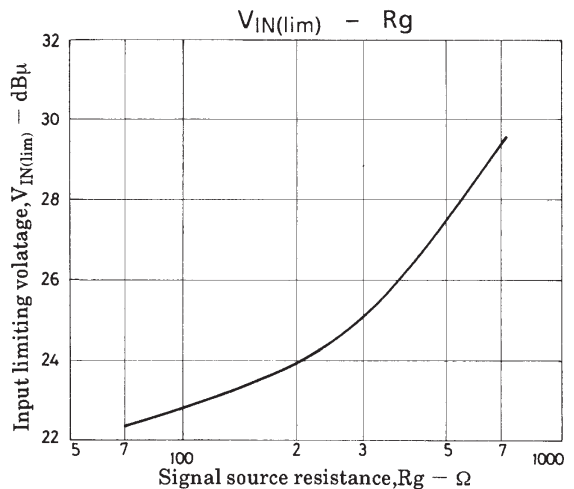
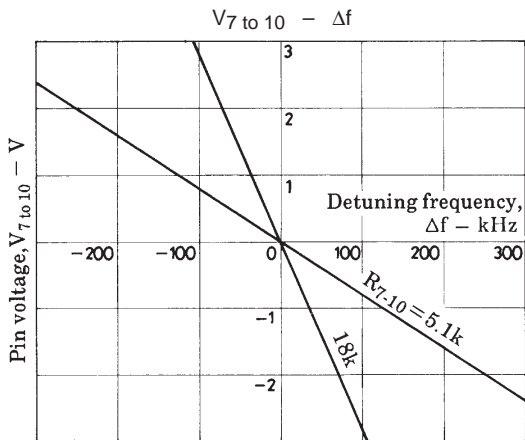
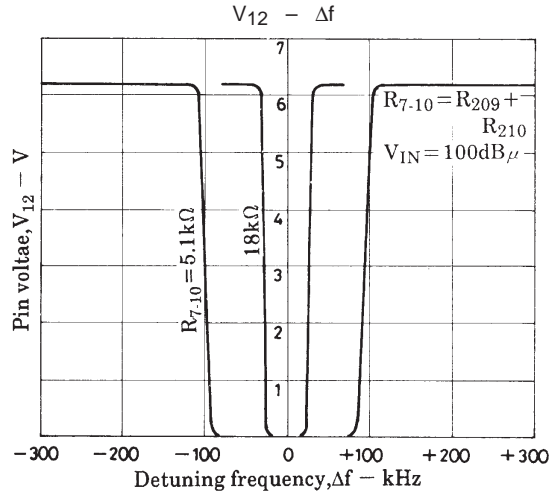
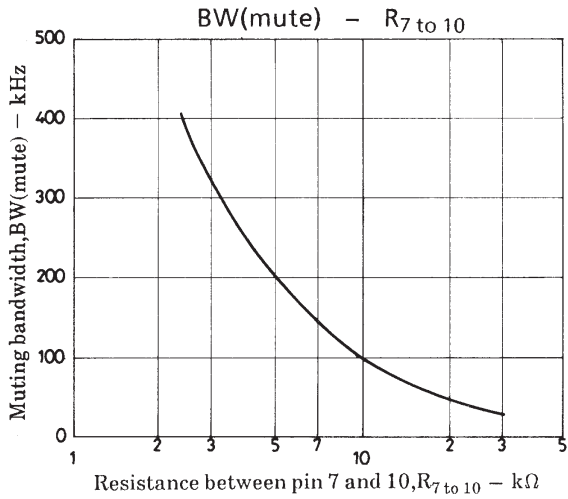
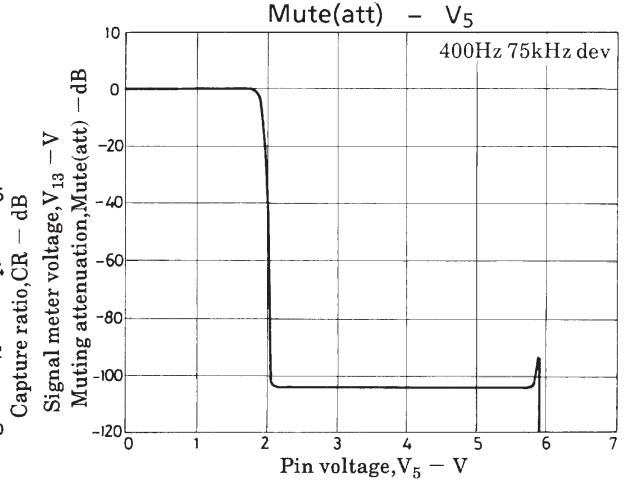
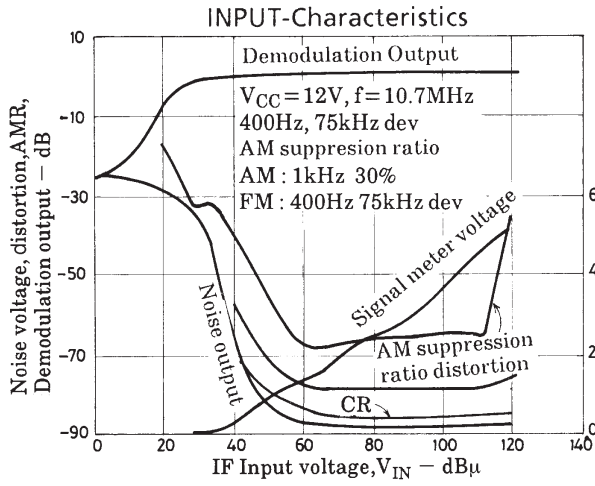

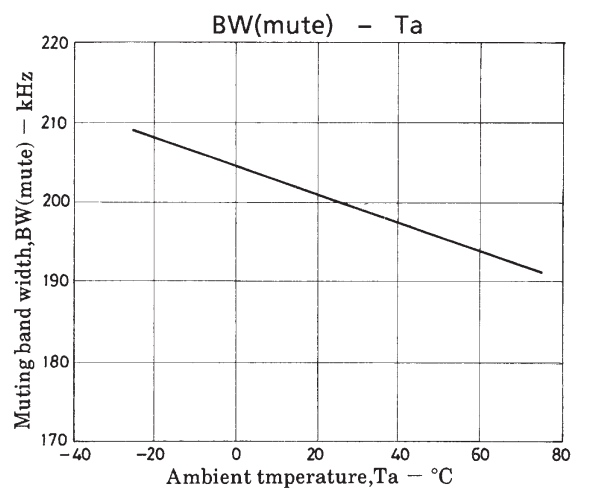
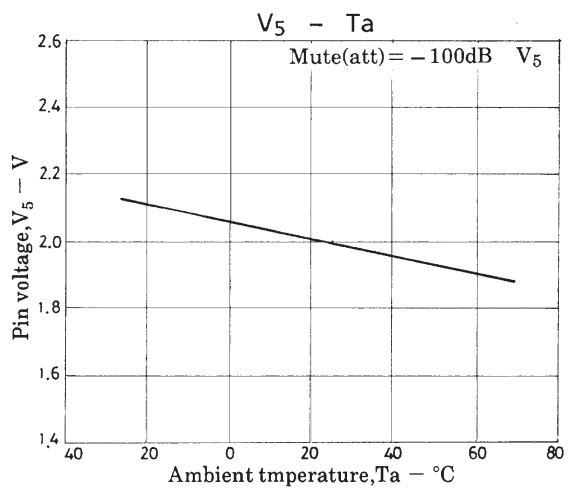
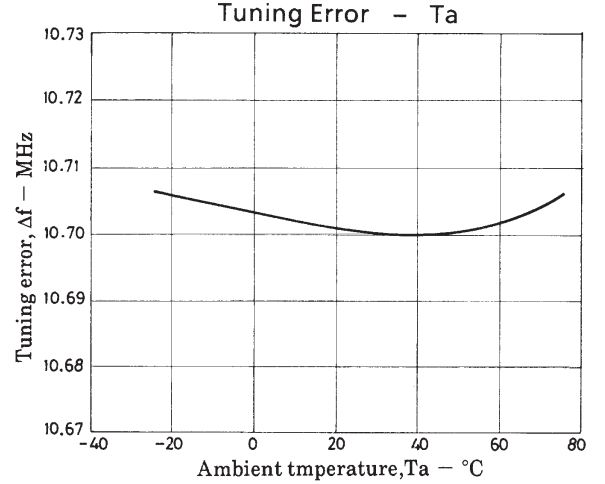
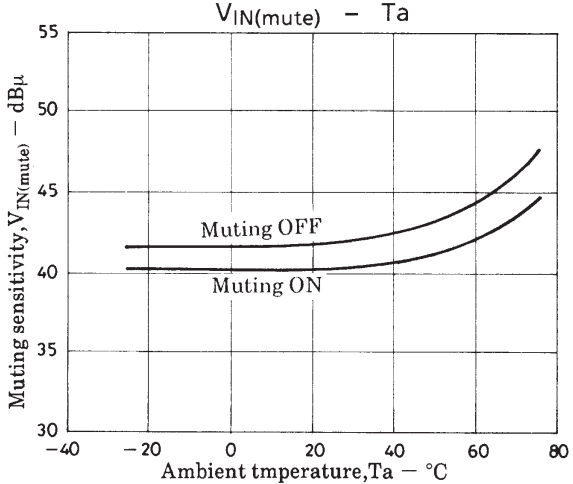
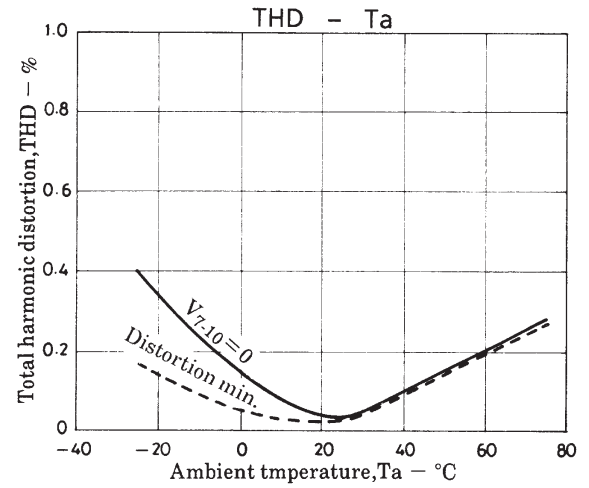
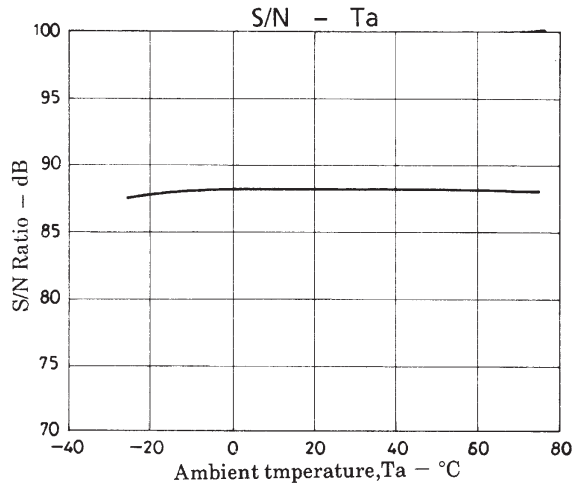
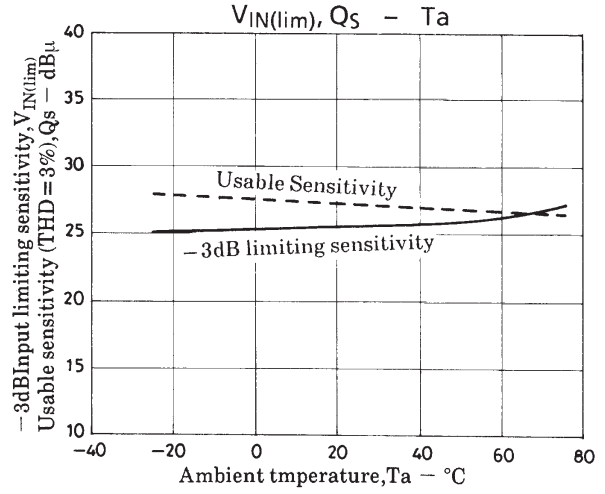
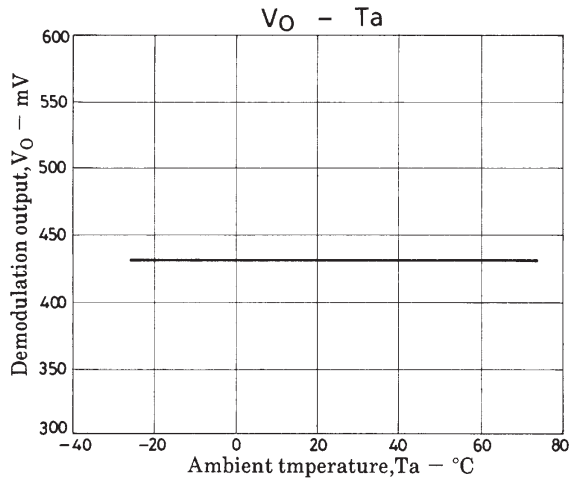

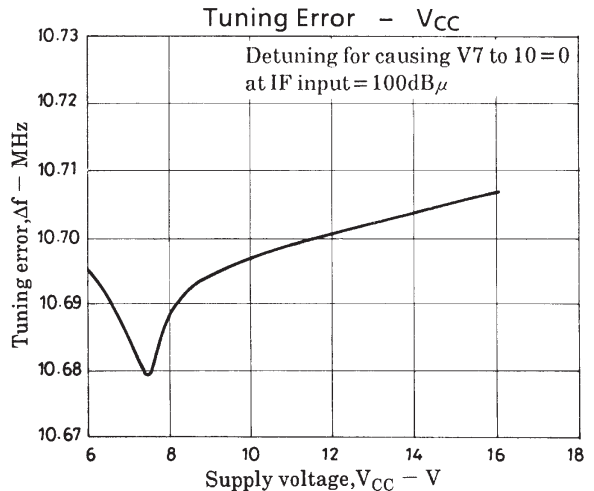
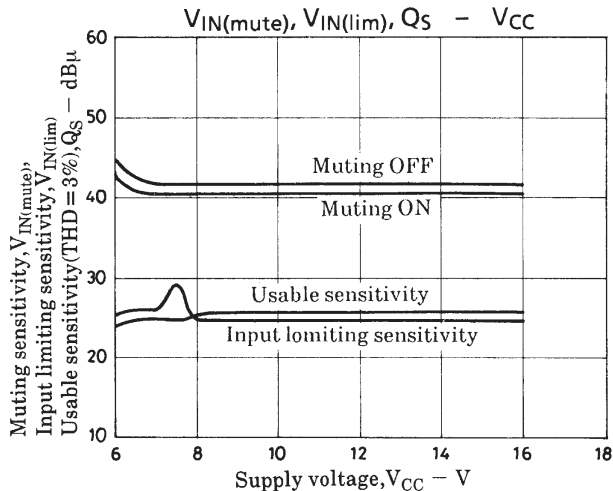
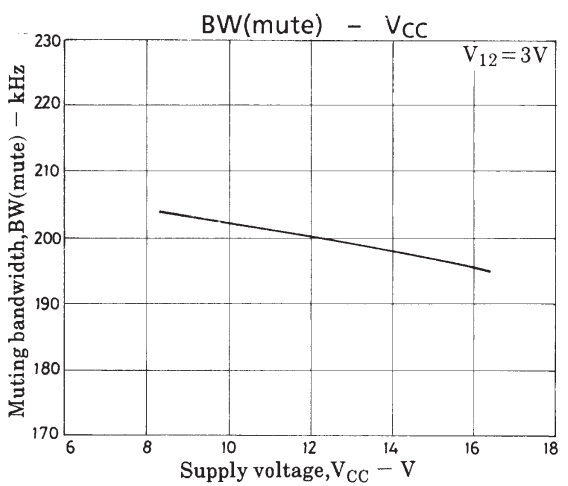
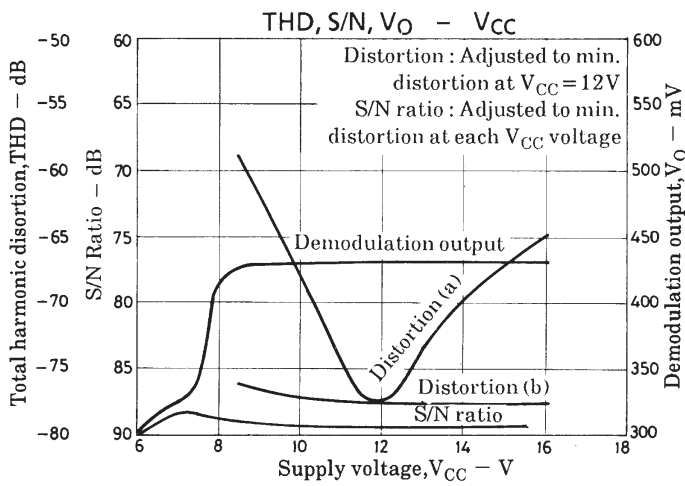
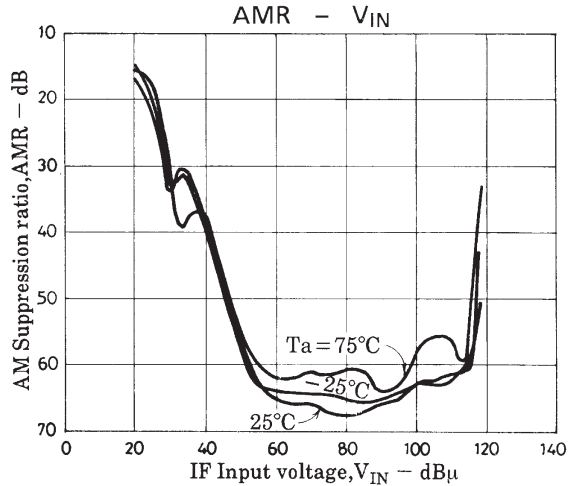
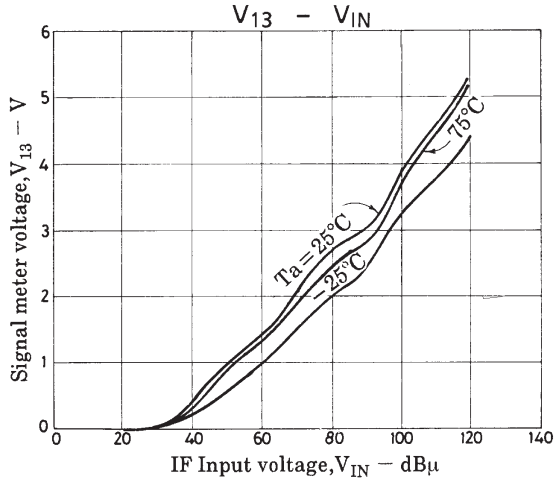
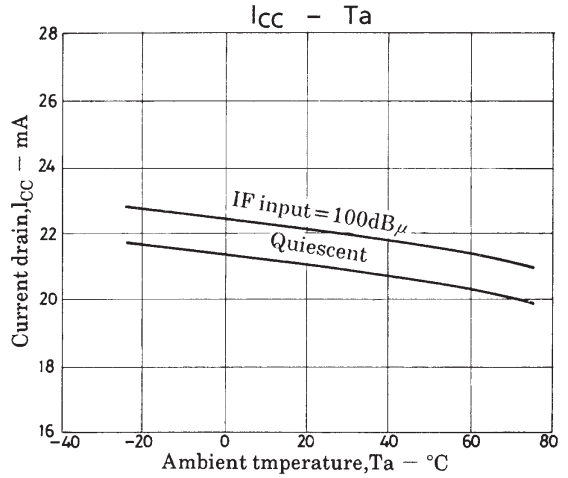
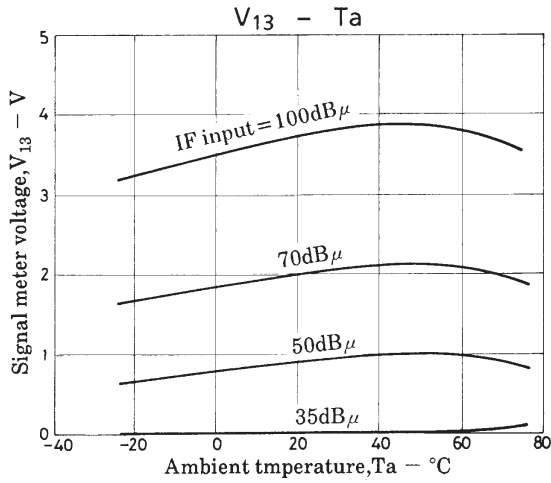

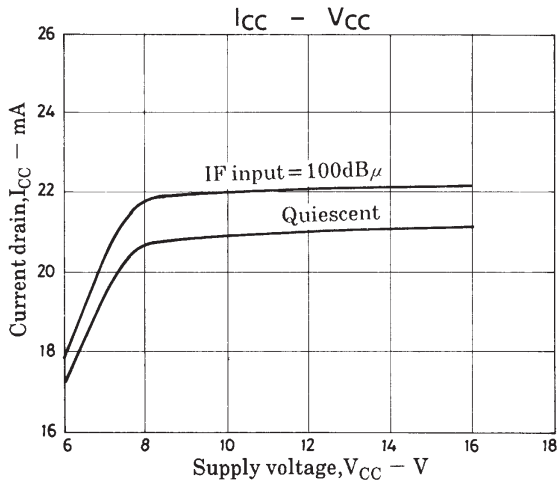

Cain distribution of application circuit

If IC anone is operated without front end, the tuning meter deflects toward plus side at the time of no input. This phenomenon is caused by the fact that the noise component to be applied to the quadrature multiplication circuit is not symumetric with respect to 10.7MHz but is shifted toward lower frequency side because the frequency characteristic of IF amplifier attenuates at high frequencies and the phase shift circuit is of low-pass type. If the formt end is attached and the noise which passes through the narrowband filter of IF stage and spreads symmetrically with respect to 10.7MHz is stronger than the noise generated inside the IC, the tuning meter reads 0.As the gain of the front end is decreased, input limiting sensitivity and usable sensitivity worsen abruptly. This phenomenon is caused by the fact that since the tuning meter is set to 0 at the time of no input the tuning point of the quadrature circuit must be shifted toward lower frequency side than 10.7MHz and the demodulation output waveform is deformed asymmetrically at an input in the vicinity of usable sensitivity. However, if the gain of the front end is too increased, the signal meter pointer does not return to zero point at the time of no signal.

Sample Application Circuit

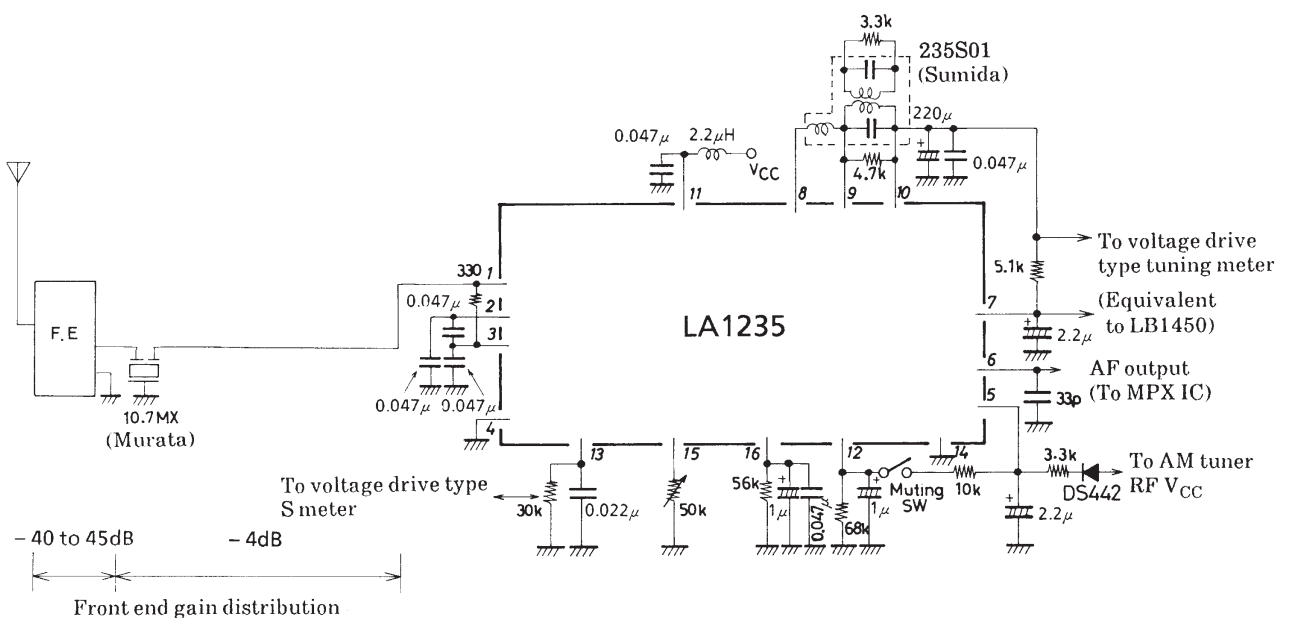

Unit (resistance : Ω , capacitance : F)

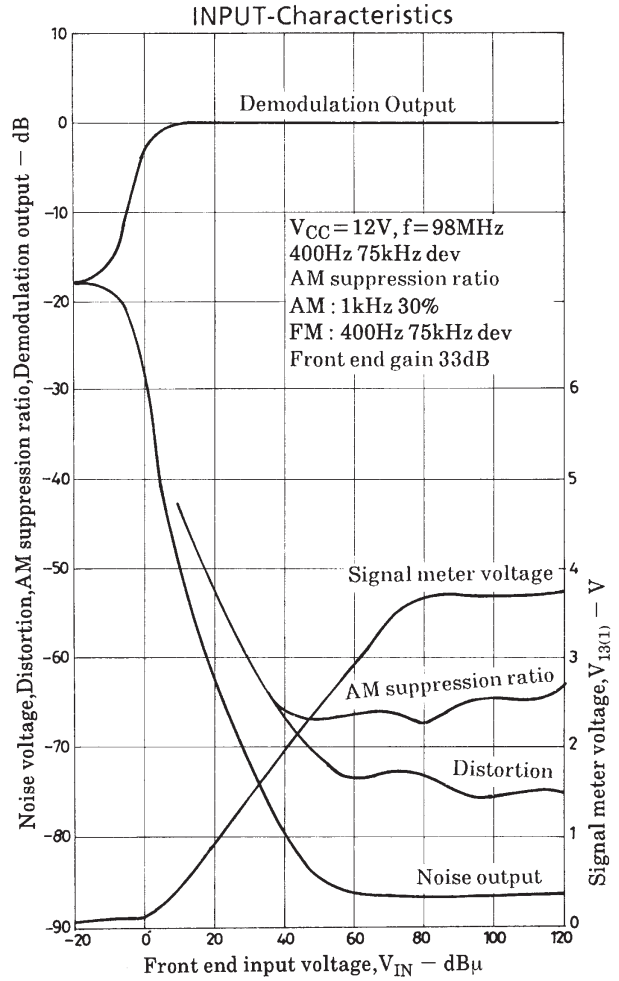
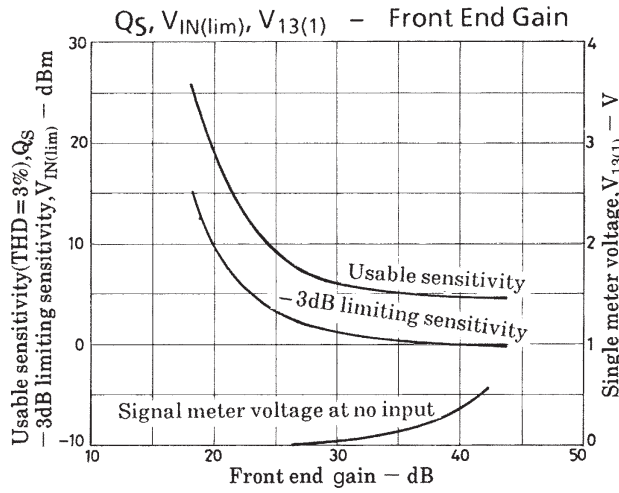

- No products described or contained herein are intended for use in surgical implants, life-support systems, aerospace equipment, nuclear power control systems, vehicles, disaster/crime-prevention equipment and the like, the failure of which may directly or indirectly cause injury, death or property loss.
- Anyone purchasing any products described or contained herein for an above-mentioned use shall:
 - ① Accept full responsibility and indemnify and defend SANYO ELECTRIC CO., LTD., its affiliates, subsidiaries and distributors and all their officers and employees, jointly and severally, against any and all claims and litigation and all damages, cost and expenses associated with such use:
 - ② Not impose any responsibility for any fault or negligence which may be cited in any such claim or litigation on SANYO ELECTRIC CO., LTD., its affiliates, subsidiaries and distributors or any of their officers and employees jointly or severally.
- Information (including circuit diagrams and circuit parameters) herein is for example only; it is not guaranteed for volume production. SANYO believes information herein is accurate and reliable, but no guarantees are made or implied regarding its use or any infringements of intellectual property rights or other rights of third parties.

This catalog provides information as of October, 1997. Specifications and information herein are subject to change without notice.

This datasheet has been download from:

www.datasheetcatalog.com

Datasheets for electronics components.