

**LA1267****FM/AM Tuner of Electronic Tuning Type****Functions**

FM : IF amplifier, quadrature detector, AF preamplifier, signal meter, tuning indicator drive output (common with stop signal, muting drive output).

AM : RF amplifier, MIX, OSC (with ALC), IF amplifier, detector, AGC, signal meter, tuning indicator drive output (common with stop signal), IF signal output.

Features

- Minimum number of external parts required.
- Excellent S/N.
- Local OSC with ALC.
- Local OSC buffer.
- Tuning indicator pin (common with narrow-band stop signal and muting drive output).
- Variable stop sensitivity (variable separately for FM, AM)
- Low whistle.
- Signal meter pin.
- Especially suited for AM stereo, IF count electronic tuning because of AM IF signal output.

Package Dimensions

unit : mm

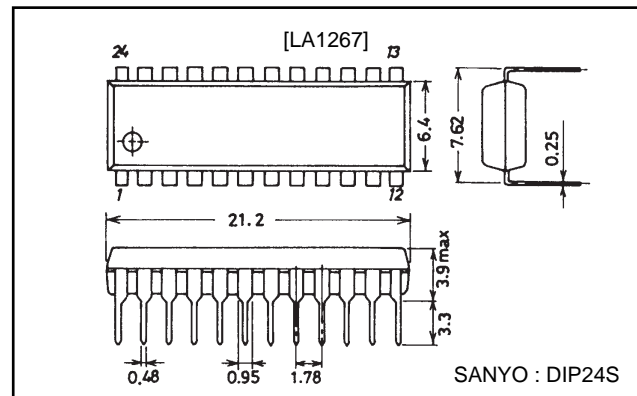
3067-DIP24S**Specifications****Maximum Ratings** at $T_a=25^\circ\text{C}$, See specified Test Circuit.

Parameter	Symbol	Conditions	Ratings	Unit
Maximum supply voltage	$V_{CC \text{ max}}$	Pins 7, 8, 19	16	V
Flow-in current	I_8	Pin 8	20	mA
Flow-out current	I_{22}	Pin 22	1	mA
	I_{24}	Pin 24	2	mA
Allowable power dissipation	$P_d \text{ max}$	$T_a \leq 60^\circ\text{C}$	650	mW
Operating temperature	T_{opr}		-20 to +70	$^\circ\text{C}$
Storage temperature	T_{stg}		-40 to +125	$^\circ\text{C}$

Operating Conditions at $T_a=25^\circ\text{C}$

Parameter	Symbol	Conditions	Ratings	Unit
Recommended operating voltage	V_{CC}		8.5	V
Operating voltage range	$V_{CC \text{ op}}$		6 to 14	V

SANYO Electric Co., Ltd. Semiconductor Business Headquarters

TOKYO OFFICE Tokyo Bldg., 1-10, 1 Chome, Ueno, Taito-ku, TOKYO, 110 JAPAN

N2897HA (KT)/40594HK/D105KI, TS No.2012-1/14

LA1267

Operating Characteristics at $T_a=25^\circ\text{C}$, $V_{CC}=8.5\text{V}$, See specified Test Circuit

Parameter	Symbol	Conditions	Ratings			Unit
			min	typ	max	
[AM : $f=1\text{MHz}$]						
Quiescent current	Icco	No input		18	26	mA
Detection output	V _{O1}	V _{IN} =20dB μ , 400Hz, 30% mod.	30	50	90	mV
	V _{O2}	V _{IN} =80dB μ , 400Hz, 30% mod.	110	160	220	mV
S/N	S/N1	V _{IN} =20dB μ	16	20		dB
	S/N2	V _{IN} =80dB μ	49	54		dB
Total harmonic distortion	THD1	V _{IN} =80dB μ , 400Hz, 30% mod.		0.3	1.0	%
	THD2	V _{IN} =107dB μ , 400Hz, 30% mod.		0.5	2.0	%
Signal meter output	V _{SM 1}	No input	0	0	0.2	V
	V _{SM 2}	V _{IN} =80dB μ	2.4	2.8	3.1	V
LED lighting sensitivity	VLED on	I _{LED} =1mA	15	24	33	dB μ
Local OSC buffer output	V _{OSC}	f _{OSC} =1.45MHz	220	275	330	mV
[FM : $f=10.7\text{MHz}$]						
Quiescent current	Icco	No input		20	28	mA
Input limiting sensitivity	-3dBLS.	3dB down, 400Hz, 100% mod.		31	37	dB μ
Demodulation output	V _O	V _{IN} =100dB μ , 400Hz, 100% mod.	240	330	460	mV
S/N	S/N	V _{IN} =100dB μ	78	84		dB
Total harmonic distortion	THD	V _{IN} =100%dB μ , 400Hz, 100% mod.		0.03	0.3	%
Signal meter output	V _{SM 1}	No input	0	0	0.2	V
	V _{SM 2}	V _{IN} =100dB μ	1.5	2.7	3.1	V
LED lighting sensitivity	LED-on	I _{LED} =1mA	35	50	65	dB μ
LED lighting bandwidth	LED-BW	V _{IN} =100dB, I _{LED} =1mA	90	120	160	kHz
AM rejection ratio	AMR	V _{IN} =100dB μ , FM=400Hz 100% mod. AM=1kHz 30% mod.	45	60		dB

Note : Be fully careful of dielectric breakdown.

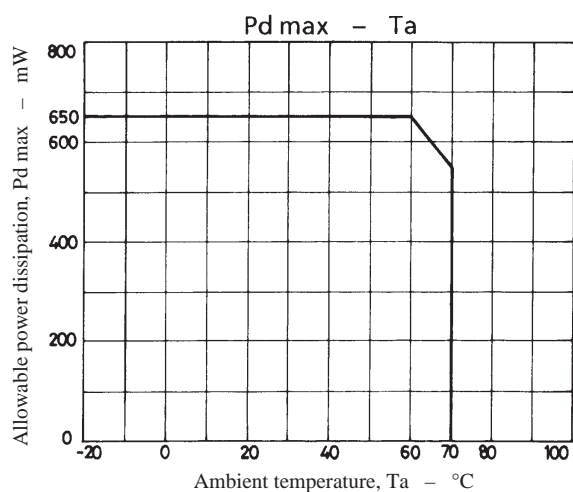

Equivalent Circuit Block Diagram

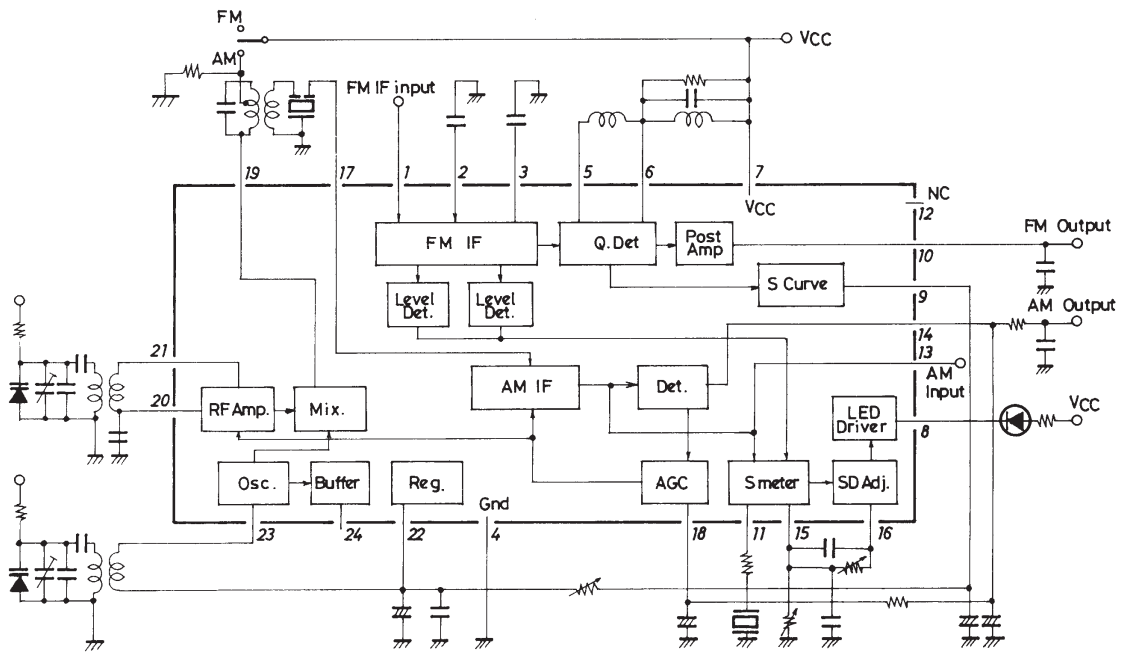

How to use the LA1267

1. LED lighting, muting drive output, stop signal (SD).

- For LED lighting, muting drive output, stop signal, the output at pin 8 is used.
- The voltage on pin 8, when tuned, turns from "H" to "L". (Active-Low)
- Signal bandwidth at pin 8.
 - For AM, the bandwidth depends on the CF (BFU450CN) at pin 11. If a capacitor is connected in place of the CF, the bandwidth will get wider.
 - For FM, the bandwidth depends on the resistance across pins 9 and 22. If the resistance is increased, the bandwidth will get narrower. $R=15k\Omega$ makes the bandwidth approximately 120kHz.

• Sensitivity adjustment of LED, muting, stop signal.

- For FM, the semifixed variable resistor across pin 15 and GND is used.
- For AM, the semifixed variable resistor across pins 15 and 16 is used. Be sure to start adjustment for FM, and then make adjustment for AM. For the stop signal sensitivity and FM stop signal bandwidth, the variations should be considered and it is recommended to use the semifixed variable resistor for adjustment.

• LED lighting sensitivity setting for AM.

For the LED lighting sensitivity setting for AM, it is desirable that the IC input be $30dB\mu$ (antenna input : approximately $50dB/m$). In this case, the value of VR1 is $30k\Omega$.

LED Lighting Bandwidth – Resistance across pins 9 and 22

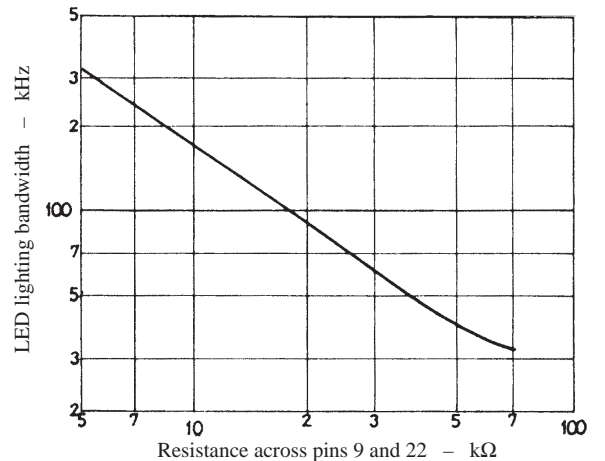

• LED lighting sensitivity setting for FM.

For the LED lighting sensitivity setting for FM, the IC input may be 45dB μ to 60dB μ . With the variations in the front end considered, it is ideal that the IC input in a standard receiving set be 51dB μ to 54dB μ . The lower value of VR2 for the LED lighting sensitivity setting is as illustrated right. Since the variations in the front end cause the IC input setting sensitivity to vary, it is recommended to use a value of VR2 at an input voltage lower than a standard setting by 6dB or greater. For example, if IC input 53dB μ is taken as a standard, use VR2 \leq 100k Ω at IC input 47dB μ .

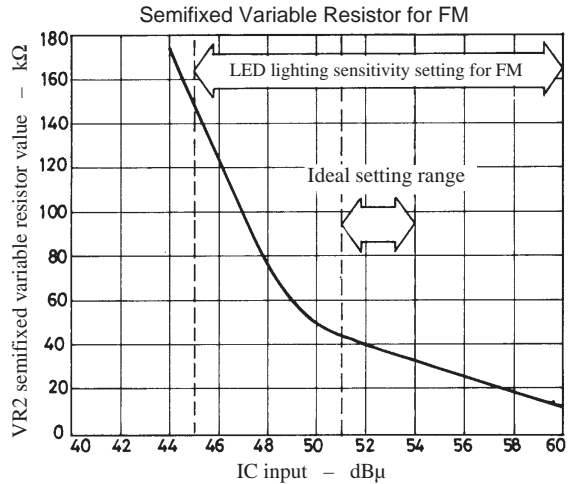

2. AM/FM changeover

- Two selections are available for changeover as shown below : (A) pin 19-used method and (B) pin 20-used method.
- For (A), the voltage on pin 19 relative to V_{CC} (pin 7) must be within the range of -0.8V to +0.1V. If not within this range, distortion and selectivity will get worse.
- For (A), a resistance of 68k Ω at the IFT cold terminal, which is used to prevent the changeover circuit from malfunctioning, must be connected.

(A) pin 19-use method for AM/FM changeover

(B) Pin 20-used method for AM/FM changeover

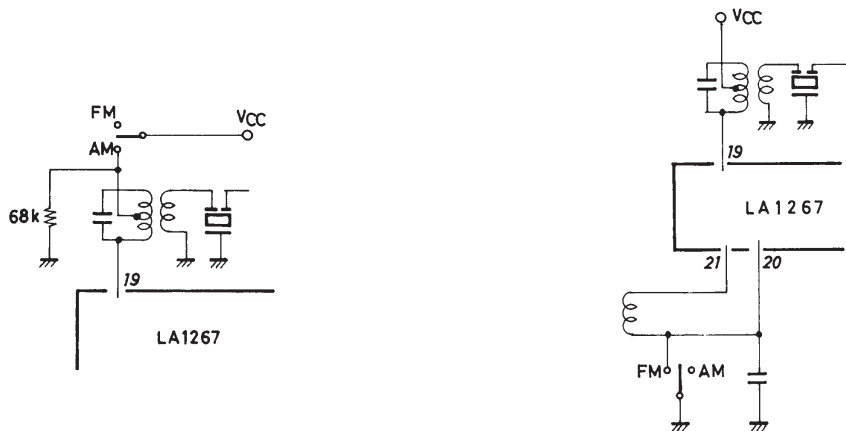

3. Local OSC buffer output

- When local OSC buffer output wave form is saw-toothed at the SW mode, connect a resistance of 1.2k Ω or thereabouts across pin 24 and GND.

4. AM input pin

- It is desirable that the AM input pin (pin 21) be L-coupled to pin 20.
- Inputting to pin 21 can be done by DC-cutting with a capacitor. However, an unbalance in the RF amplifier (differential amplifier) causes gain drop and whistle worsening.

5. Capacitance across pin 9 and GND.

A large capacitance across pin 9 and GND may cause a misstop at an adjacent channel when the channel select speed is made faster at the automatic channel select mode. In this case, decrease the capacitance across pin 9 and GND. However, if too decreased, the LED will flutter at low modulation frequencies at the time of detuning. Therefore, it is recommended to fix the capacitance across pin 9 and GND to be 3.3 μ F to 10 μ F. The relation between modulation frequency and demodulation output voltage on pin 9 with the capacitance across pin 9 and GND as a parameter is shown right.

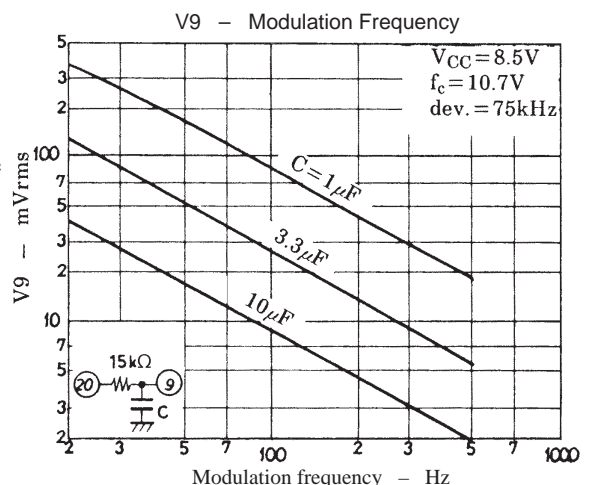

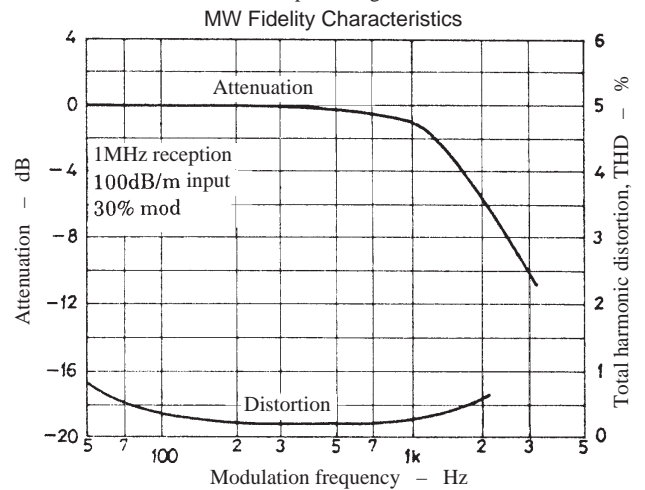
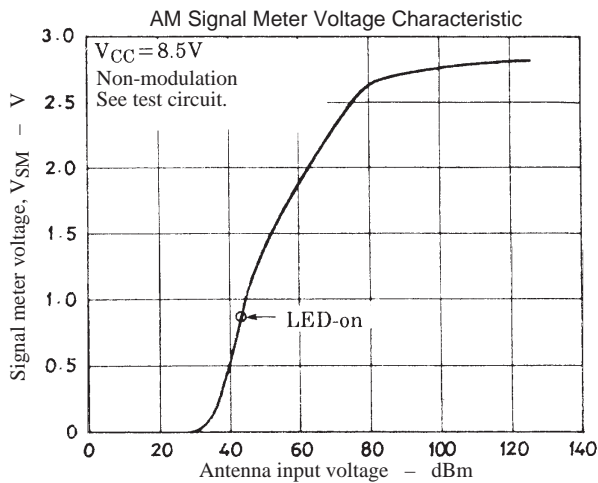
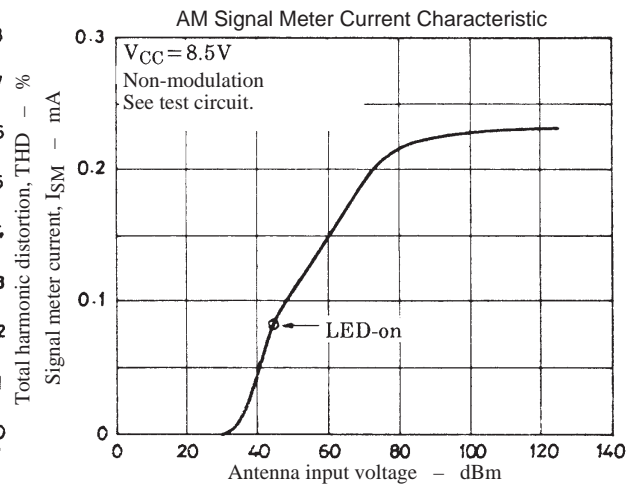
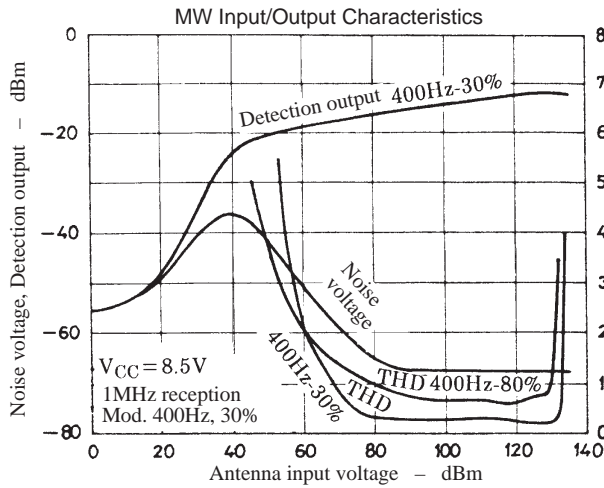
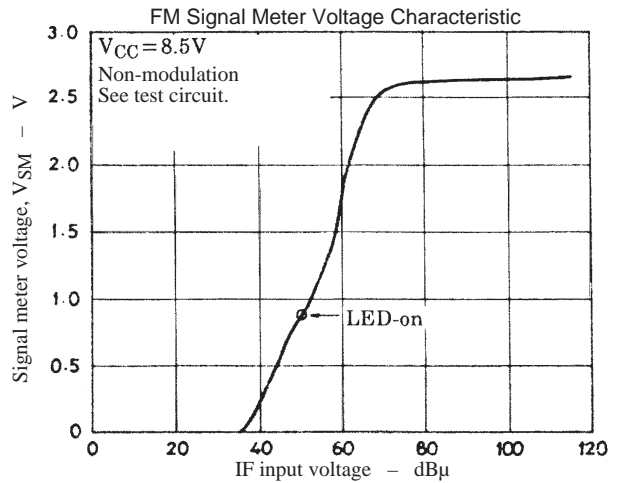
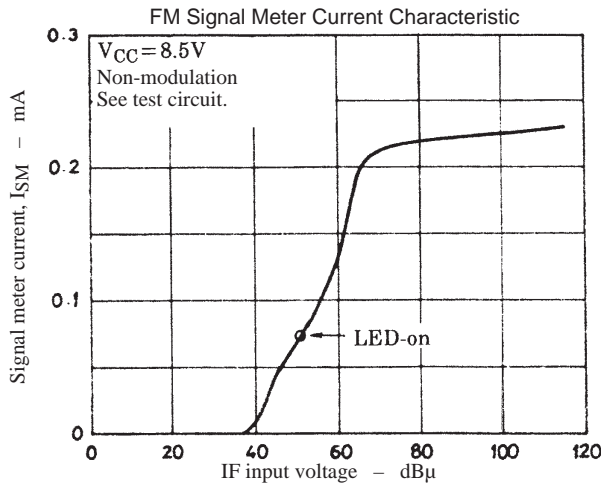
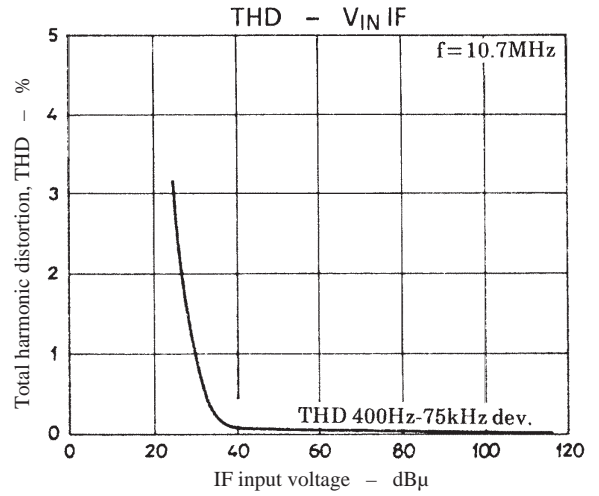
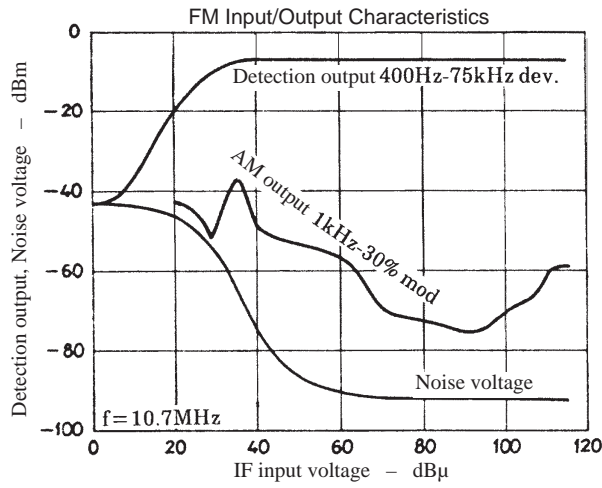

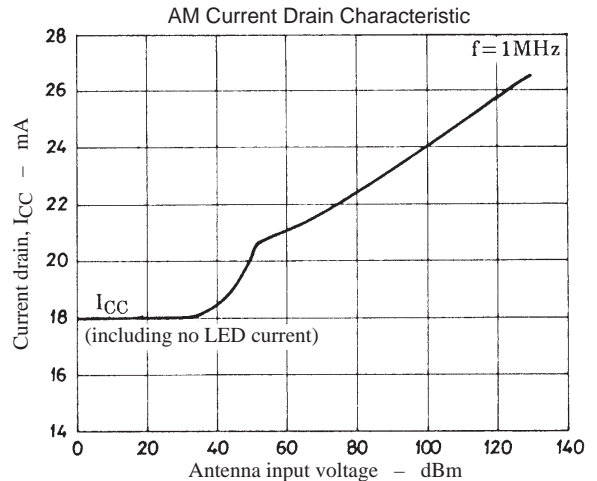
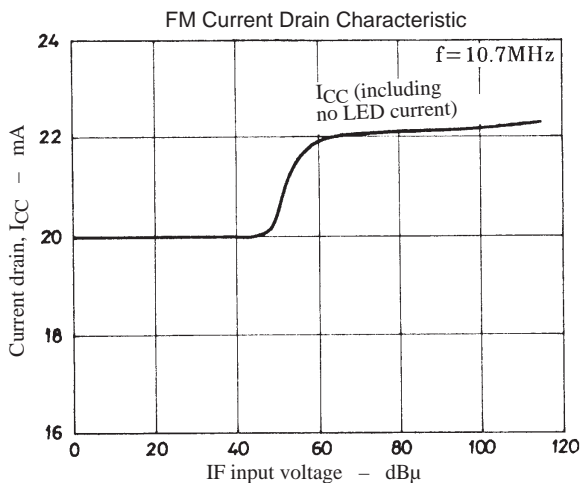
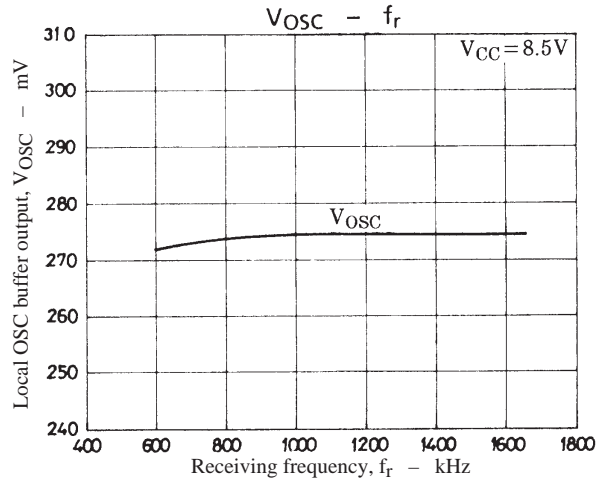
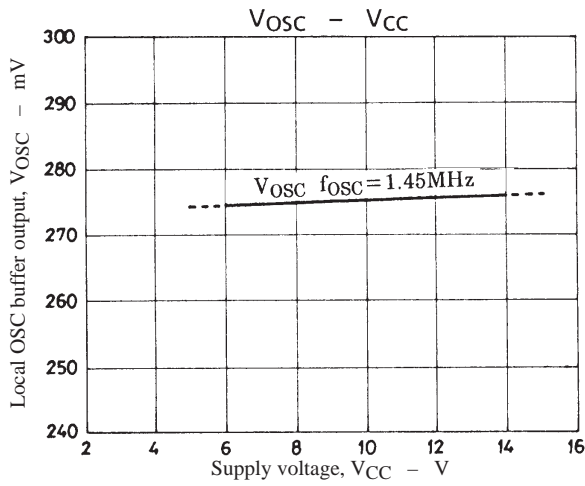
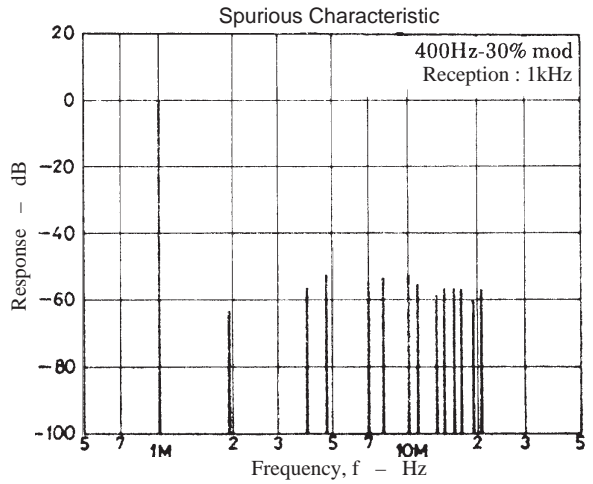
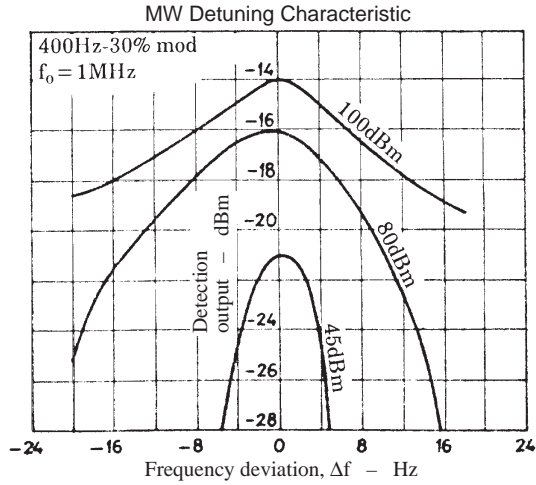
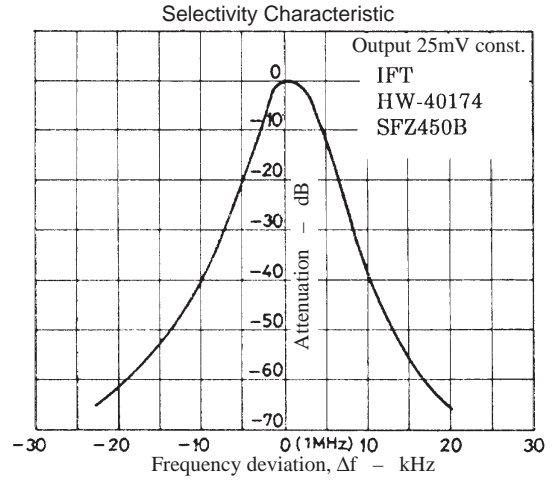
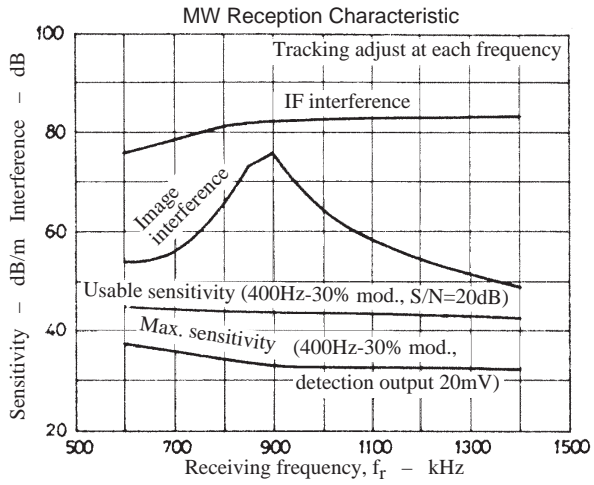

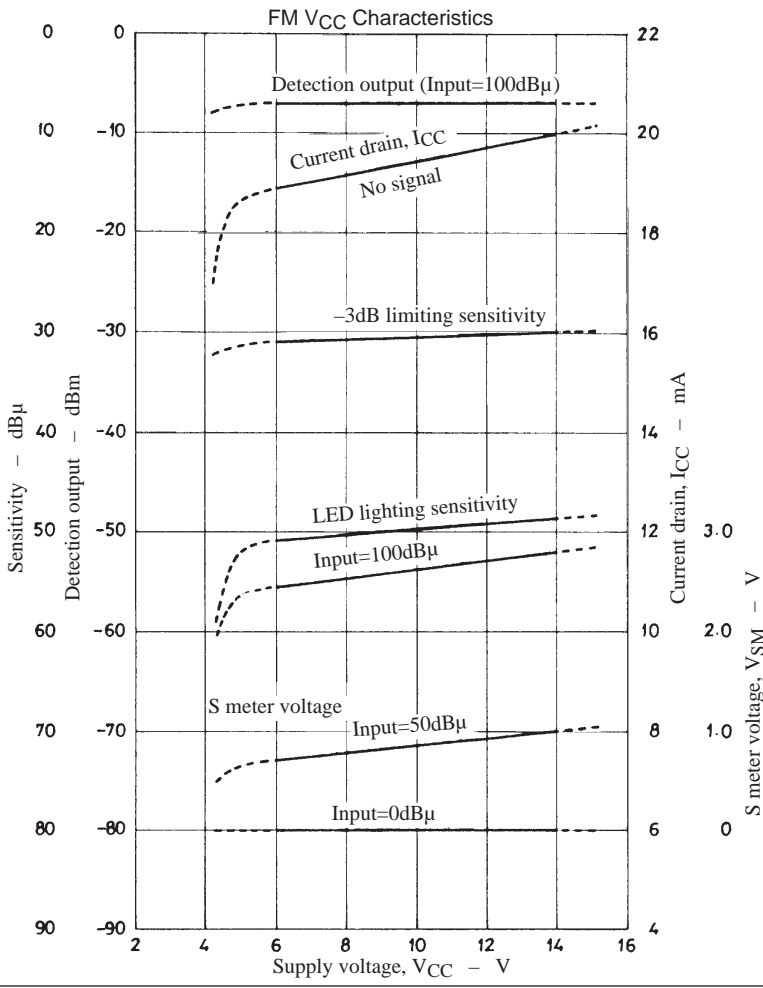
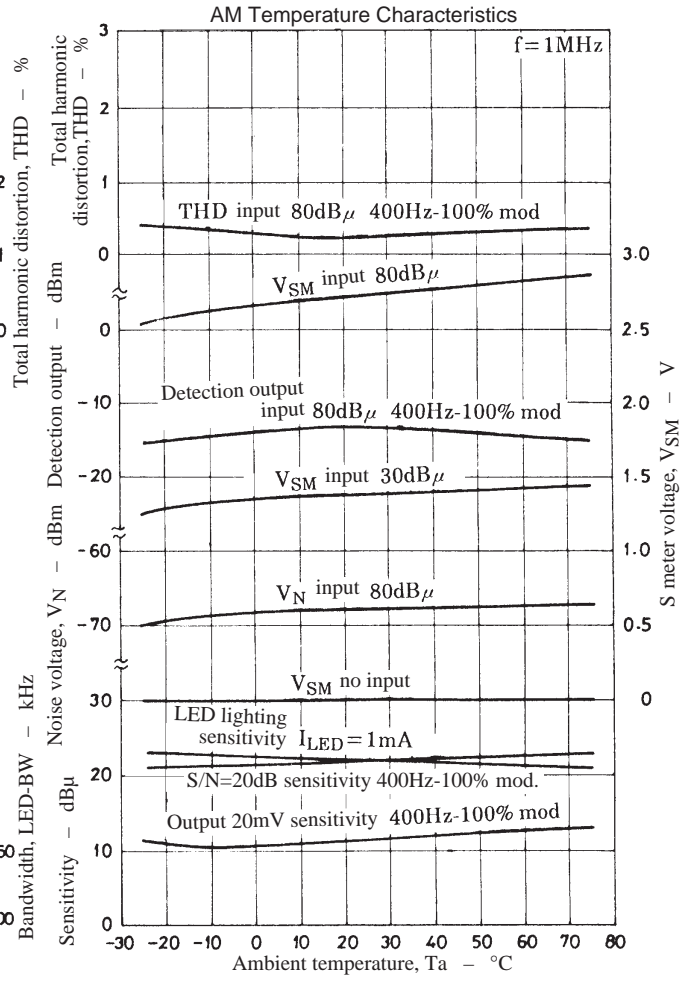
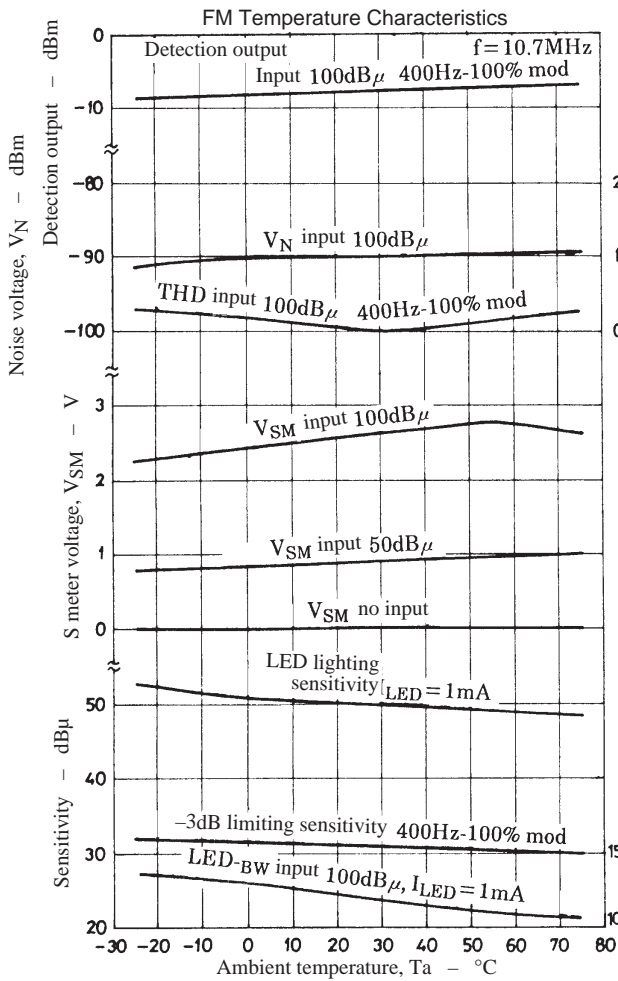

LA1267

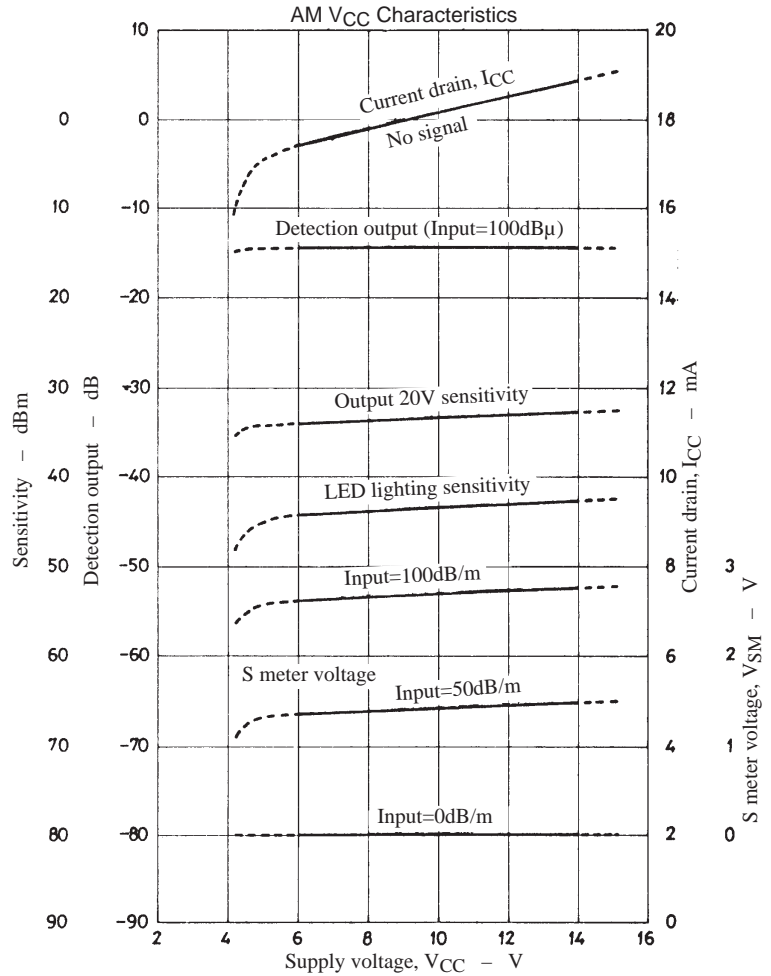

Test Circuit : SW2

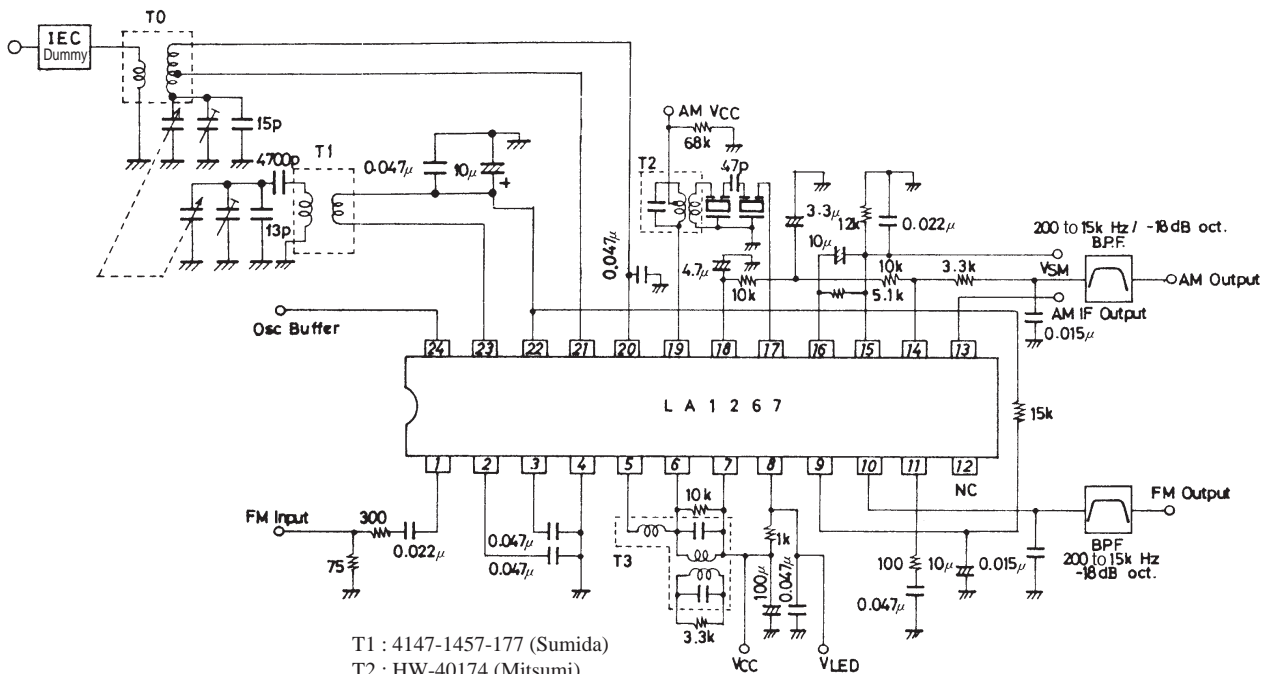

T1 : 4147-1457-177 (Sumida)
 T2 : HW-40174 (Mitsumi)
 T3 : HW-40130, 40131 (Mitsumi)

Unit (resistance : Ω , capacitance : F)

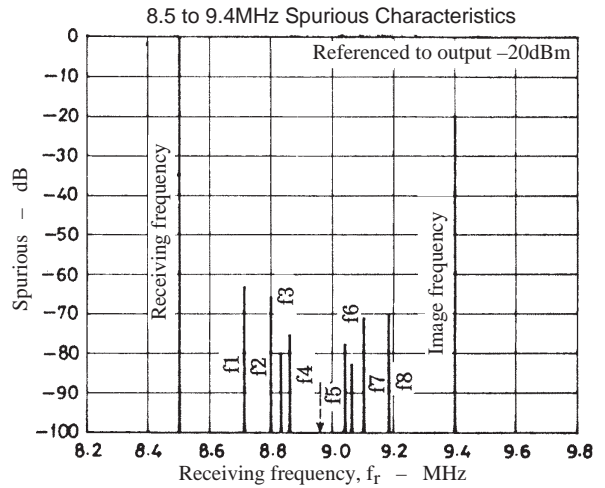
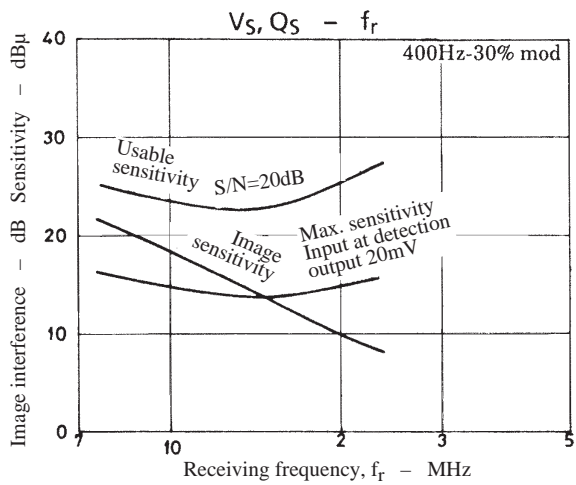
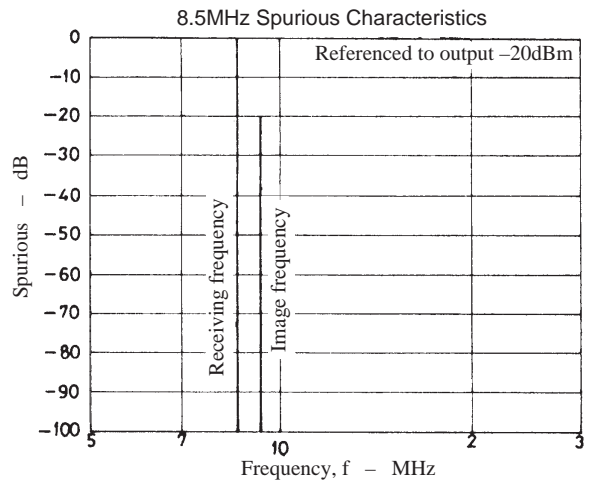
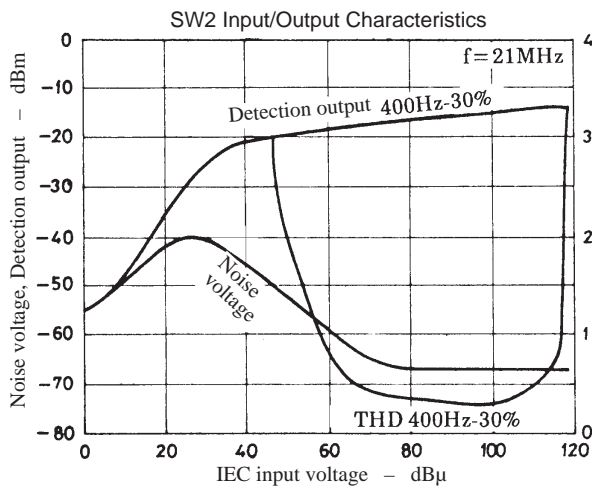
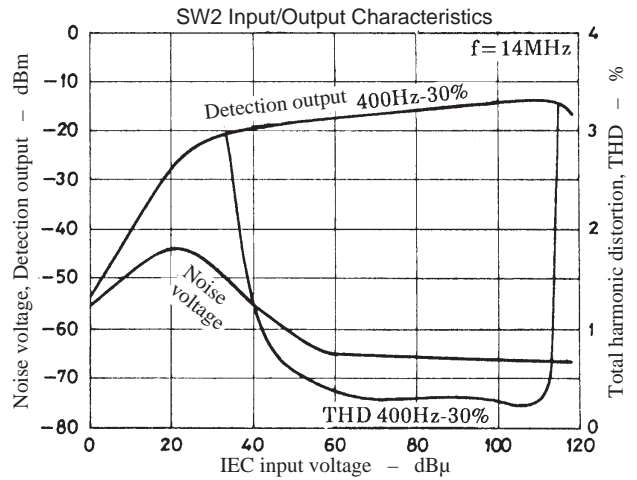
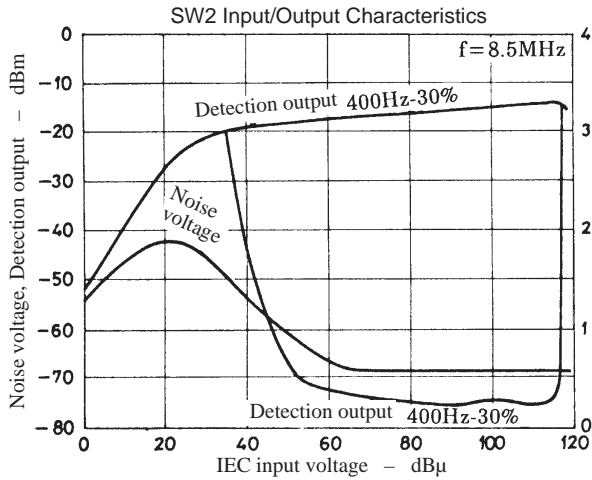

- f1 : 8.724MHz → 2f_{OSC}-2f1 = 455kHz
- f2 : 8.799MHz → 3f_{OSC}-3f2 = 455kHz
- f3 : 8.836MHz → 4f_{OSC}-4f3 = 455kHz
- f4 : 8.859MHz → 5f_{OSC}-5f4 = 455kHz
- f5 : 9.038MHz → 5f5-5f_{OSC} = 455kHz
- f6 : 9.061MHz → 4f6-4f_{OSC} = 455kHz
- f7 : 9.098MHz → 3f7-3f_{OSC} = 455kHz
- f8 : 9.173MHz → 2f8-2f_{OSC} = 455kHz

Coil Specifications

MW antenna

Bar antenna (for PVC22KTL)

- TN-10896 (Mitsumi)

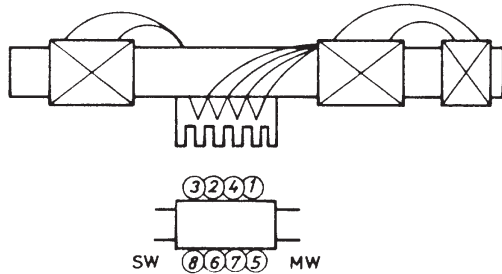

- ①-② 22T + 49T, ③-④ 10T
- Tight solenoid direct winding
- ⑤-⑥ 17T 0.5φ space winding
- ⑦-⑧ 4T tight solenoid winding
- ①-② $L = 260\mu\text{H}$, $Q_0 = 330 (\geq 200)$
- ⑤-⑥ $L = 15\mu\text{H}$, $Q_0 = 250 (\geq 150)$

Loop antenna (for SVC321)

- LA300 (Korin Giken)

Loop antenna matching coil

- KT-412

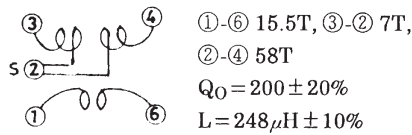

- ①-⑥ 15.5T, ③-② 7T,
- ②-④ 58T
- $Q_0 = 200 \pm 20\%$
- $L = 248\mu\text{H} \pm 10\%$

MW OSC

- 4147-1457-177 (Sumida)

For PVC22KTL

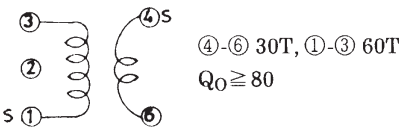

- ④-⑥ 30T, ①-③ 60T
- $Q_0 \geq 80$

- KO-387 (Korin Giken)

For SVC321

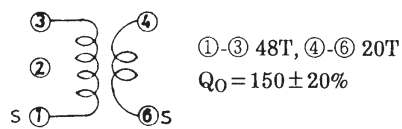

- ①-③ 48T, ④-⑥ 20T
- $Q_0 = 150 \pm 20\%$

AM-IFT

Matching coil for SFU450B (1-element type)

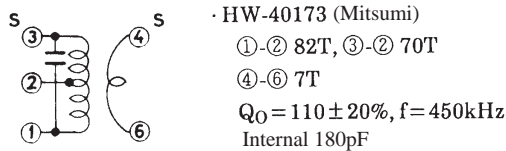

- HW-40173 (Mitsumi)
- ①-② 82T, ③-② 70T
- ④-⑥ 7T
- $Q_0 = 110 \pm 20\%$, $f = 450\text{kHz}$
- Internal 180pF

- 2150-2162-197 (Sumida)
- ①-② 103T, ③-② 71T,
- ④-⑥ 8T
- $Q_0 \geq 80$, $f = 450\text{kHz}$
- Internal 180pF

Matching coil for SFZ450B (2-element type)

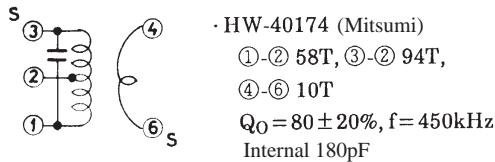

- HW-40174 (Mitsumi)
- ①-② 58T, ③-② 94T,
- ④-⑥ 10T
- $Q_0 = 80 \pm 20\%$, $f = 450\text{kHz}$
- Internal 180pF

- 2150-2061-049 (Sumida)
- ①-② 54T, ③-② 120T,
- ④-⑥ 12T
- $Q_0 \geq 40$
- Internal 180pF

FM single tuning detection coil

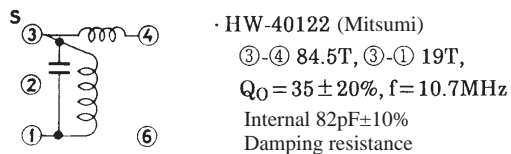

- HW-40122 (Mitsumi)
- ③-④ 84.5T, ③-① 19T,
- $Q_0 = 35 \pm 20\%$, $f = 10.7\text{MHz}$
- Internal 82pF $\pm 10\%$
- Damping resistance

- 2231-016 (Sumida)
- ③-④ 73.5T, ③-① 19T,
- $Q_0 = 30 \pm 20\%$, $f = 10.7\text{MHz}$
- Internal 82pF $\pm 10\%$
- Damping resistance

FM double tuning detection coil

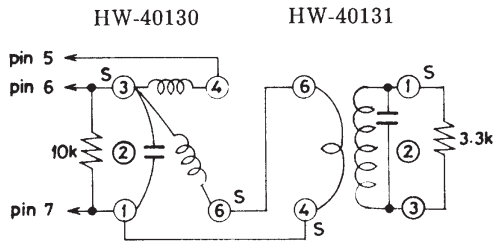

- HW-40130 (Mitsumi)
 - ③-④ 86.5T
 - ③-⑥ 13.5T
 - $Q_0 = 50 \pm 20\%$
 - Internal 100pF $\pm 10\%$

- HW-40131 (Mitsumi)
 - ④-⑥ 1T
 - ①-③ 19T
 - $Q_0 = 35 \pm 20\%$
 - Internal 100pF $\pm 10\%$

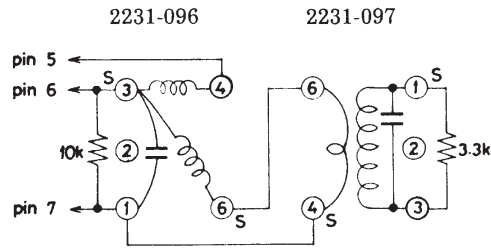

- 2231-096 (Sumida)
 - ③-④ 73.5T
 - ③-⑥ 23.5T
 - $Q_0 = 50 \pm 20\%$
 - Internal 62pF $\pm 10\%$

- 2231-097 (Sumida)
 - ④-⑥ 2T
 - ①-③ 21T
 - $Q_0 = 47 \pm 20\%$
 - Internal 82pF $\pm 10\%$

Unit (resistance : Ω)

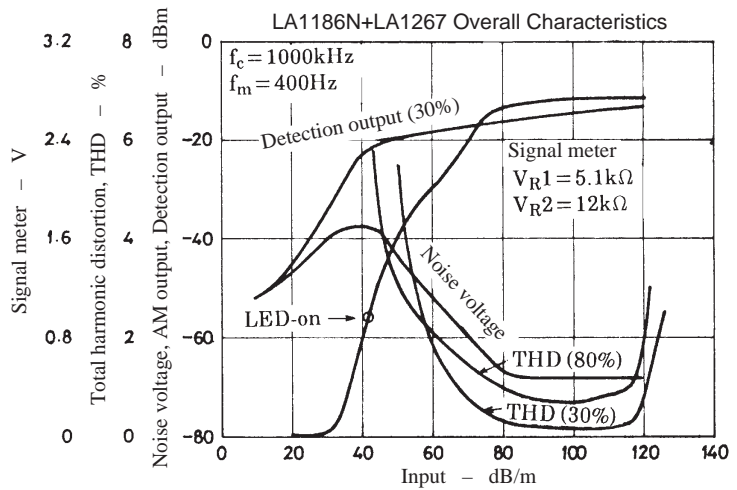
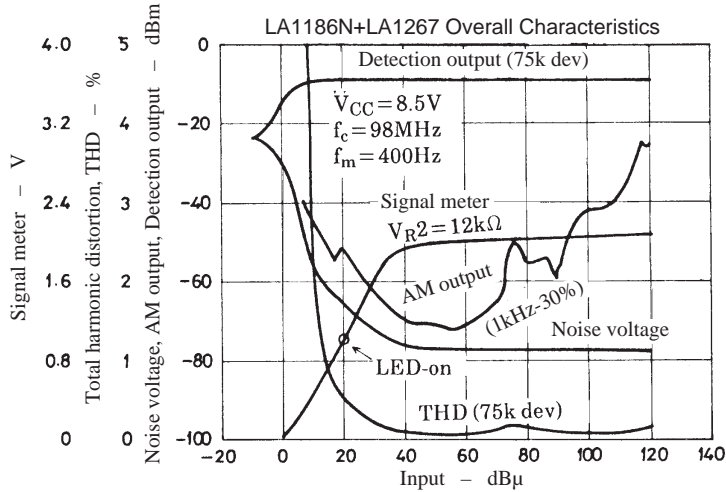

- No products described or contained herein are intended for use in surgical implants, life-support systems, aerospace equipment, nuclear power control systems, vehicles, disaster/crime-prevention equipment and the like, the failure of which may directly or indirectly cause injury, death or property loss.
- Anyone purchasing any products described or contained herein for an above-mentioned use shall:
 - ① Accept full responsibility and indemnify and defend SANYO ELECTRIC CO., LTD., its affiliates, subsidiaries and distributors and all their officers and employees, jointly and severally, against any and all claims and litigation and all damages, cost and expenses associated with such use:
 - ② Not impose any responsibility for any fault or negligence which may be cited in any such claim or litigation on SANYO ELECTRIC CO., LTD., its affiliates, subsidiaries and distributors or any of their officers and employees jointly or severally.
- Information (including circuit diagrams and circuit parameters) herein is for example only; it is not guaranteed for volume production. SANYO believes information herein is accurate and reliable, but no guarantees are made or implied regarding its use or any infringements of intellectual property rights or other rights of third parties.

This catalog provides information as of November, 1997. Specifications and information herein are subject to change without notice.

This datasheet has been download from:

www.datasheetcatalog.com

Datasheets for electronics components.