

HIGH PERFORMANCE DUAL DECOMPENSATED
OPERATIONAL AMPLIFIER

DESCRIPTION

The μ PC4556 is a dual operational amplifier which features further advanced A.C. performance than that of the μ PC4558. Decompensation characteristic guarantees 20MHz gain-bandwidth product higher than 20 dB. Also featured are low input noise and high output drive capability making this device the optimum choice for audio application.

FEATURES

- Gain bandwidth products: 20 MHz ($A_v \geq 20$ dB)
- High slew rate: 5 V/ μ s
- Low input noise voltage 6 μ Vp-p
- Internal frequency compensation ($A_v \geq 20$ dB)

EQUIVALENT CIRCUIT

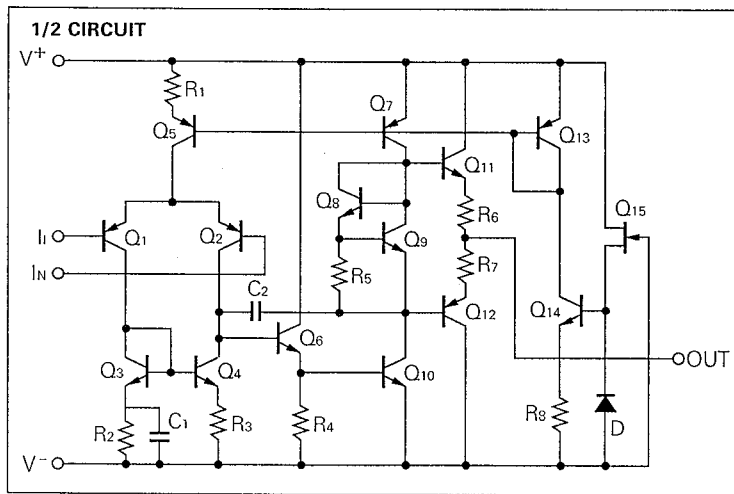

CONNECTION DIAGRAM (Top View)

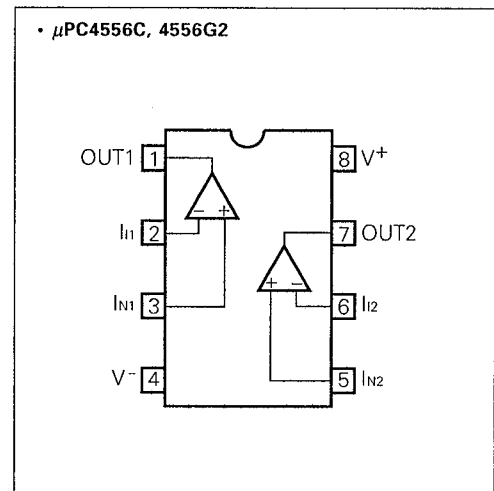

ORDERING INFORMATION

PART NUMBER	PACKAGE	QUALITY GRADE
μ PC4556C	8 PIN PLASTIC DIP (300 mil)	Standard
μ PC4556G2	8 PIN PLASTIC SOP (225 mil)	Standard

Please refer to "Quality grade on NEC Semiconductor Devices" (Document number IEI-1209) published by NEC Corporation to know the specification of quality grade on the devices and its recommended applications.

ABSOLUTE MAXIMUM RATINGS (T_a=25 °C)

PARAMETER		SYMBOL	μPC4556	UNIT
Voltage between V ⁺ and V ⁻ (Note 1)		V ⁺ - V ⁻	-0.3 to +36	V
Differential Input Voltage		V _{IO}	±30	V
Input Voltage (Note 2)		V _I	V ⁻ -0.3 to V ⁺ +0.3	V
Output Voltage (Note 3)		V _O	V ⁻ -0.3 to V ⁺ +0.3	V
Power Dissipation	C Package (Note 4)	P _T	700	mW
	G2 Package (Note 5)		440	mW
Output Short Circuit Duration (Note 6)			Indefinite	sec
Operating Temperature Range		T _{opt}	-20 to +80	°C
Storage Temperature Range		T _{stg}	-55 to +125	°C

- Note 1.** Reverse connection of supply voltage can cause destruction.
- Note 2.** The input voltage should be allowed to input without damage or destruction. Even during the transition period of supply voltage, power on/off etc., this specification should be kept. The normal operation will establish when the both inputs are within the Common Mode Input Voltage Range of electrical characteristics.
- Note 3.** This specification is the voltage which should be allowed to supply to the output terminal from external without damage or destruction. Even during the transition period of supply voltage, power on/off etc., this specification should be kept. The output voltage of normal operation will be the Output Voltage Swing of electrical characteristics.
- Note 4.** Thermal derating factor is -7.0 mV/°C when ambient temperature is higher than 25 °C.
- Note 5.** Thermal derating factor is -4.4 mV/°C when ambient temperature is higher than 25 °C.
- Note 6.** Pay careful attention to the total power dissipation not to exceed the absolute maximum ratings, Note 4 and Note 5.

RECOMMENDED OPERATING CONDITIONS

CHARACTERISTIC	SYMBOL	MIN.	TYP.	MAX.	UNIT
Supply Voltage	V [±]	±4		±16	V

ELECTRICAL CHARACTERISTICS (T_a = 25 °C, V[±] = ±15 V)

CHARACTERISTIC	SYMBOL	MIN.	TYP.	MAX.	UNIT	TEST CONDITIONS
Input Offset Voltage	V _{IO}		±0.5	±6.0	mV	R _L ≤ 10 kΩ
Input Offset Current (Note 7)	I _{IO}		±5	±200	nA	
Input Bias Current (Note 7)	I _B		180	500	nA	
Large Signal Voltage Gain	A _v	20,000	100,000			R _L ≥ 2 kΩ, V _O = ±10 V
Power Consumption	P _d		90	170	mW	I _O = 0 A, Both Amplifiers
Common Mode Rejection Ratio	CMR	70	90		dB	R _S ≤ 10 kΩ
Supply Voltage Rejection Ratio	SVR		30	150	μV/V	R _S ≤ 10 kΩ
Output Voltage Swing	V _{OM}	±12	±14		V	R _L ≥ 2 kΩ
Output Voltage Swing	V _{OM}	±10	±11.5		V	I _O = ±25 mA
Common Mode Input Voltage Range	V _{ICM}	±12	±14		V	
Slew Rate	SR		5		V/s	A _v ≥ 10 (20 dB)
Input Equivalent Noise Voltage	V _n		6		μVp-p	R _S = 1 kΩ, f = 1 Hz to 1 kHz
Channel Separation			105		dB	f = 1 kHz

- Note 7.** Input bias currents flow out from IC. Because each currents are base current of PNP-transistor on input stage.

TYPICAL APPLICATION CIRCUIT

Noninverting Amplifier

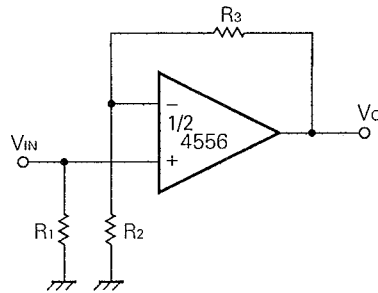

$$R_3 \geq 9 \cdot R_2$$

$$R_1 = R_2$$

Inverting Amplifier

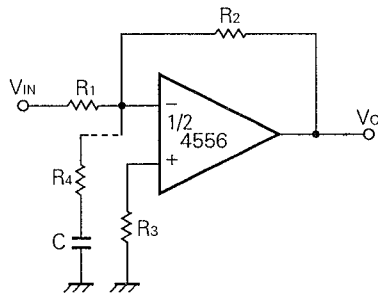

R_4, C are necessary
when $R_2 < 10 \cdot R_1$

$$R_4 \leq \frac{1}{9} R_2$$

$$C \geq \frac{R_2/R_4}{2 \cdot \pi \cdot R_4 \cdot 5 \text{ MHz}}$$

TYPICAL PERFORMANCE CHARACTERISTICS ($T_a=25^\circ\text{C}$, TYP.)

POWER DISSIPATION

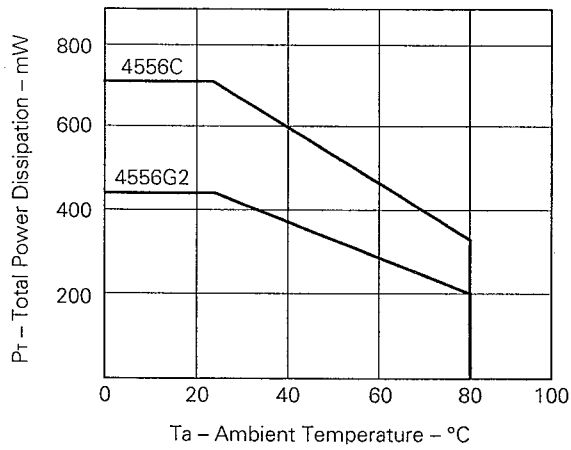

OPEN LOOP FREQUENCY RESPONSE

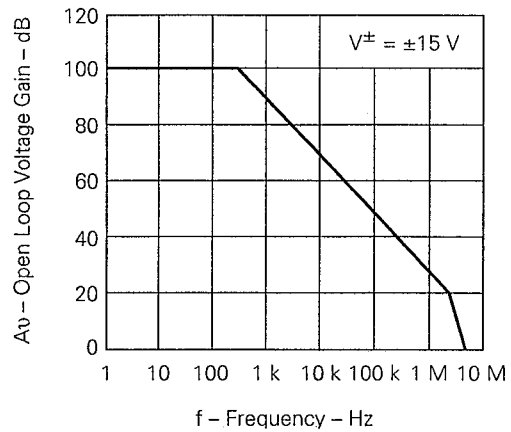

LARGE SIGNAL FREQUENCY RESPONSE

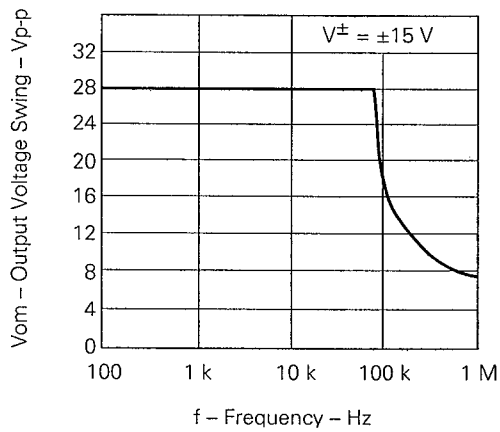

OUTPUT CURRENT LIMIT

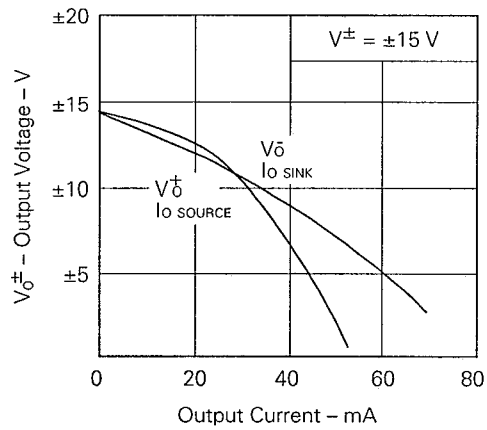

INPUT BIAS CURRENT

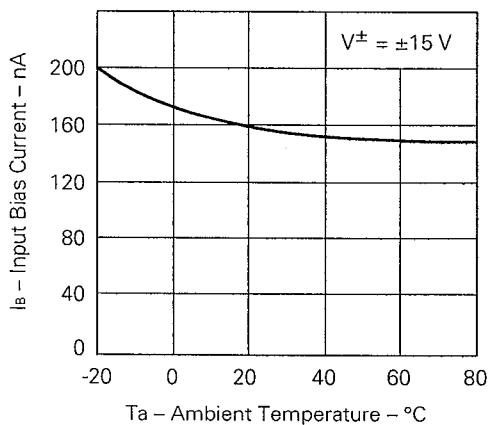

SUPPLY CURRENT

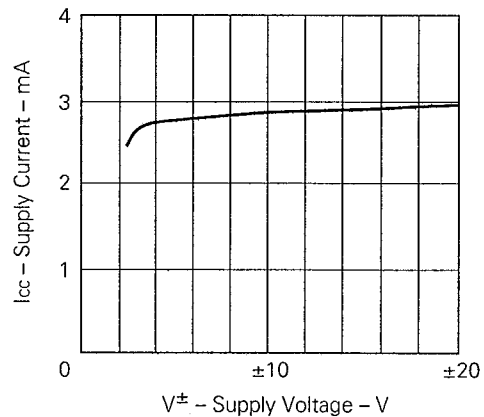

COMMON MODE INPUT VOLTAGE RANGE

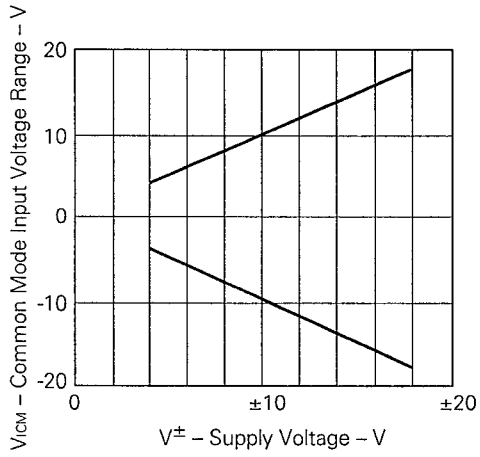

VOLTAGE FOLLOWER PULSE RESPONSE

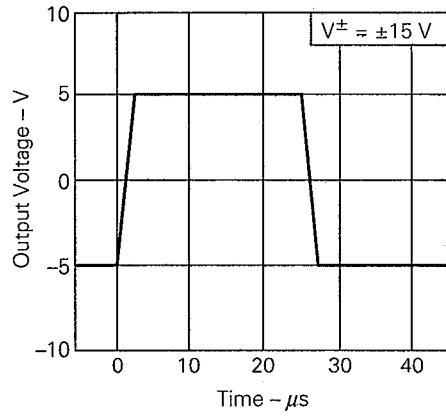

INPUT EQUIVALENT NOISE VOLTAGE DENSITY

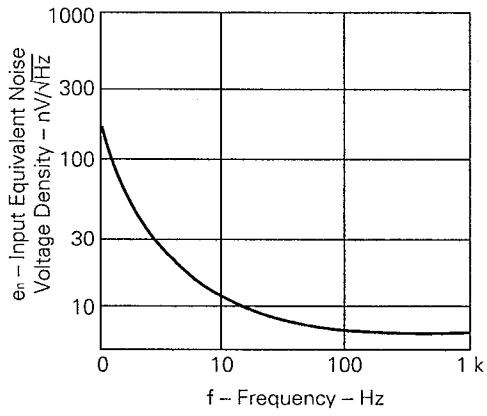

8PIN PLASTIC DIP (300 mil)

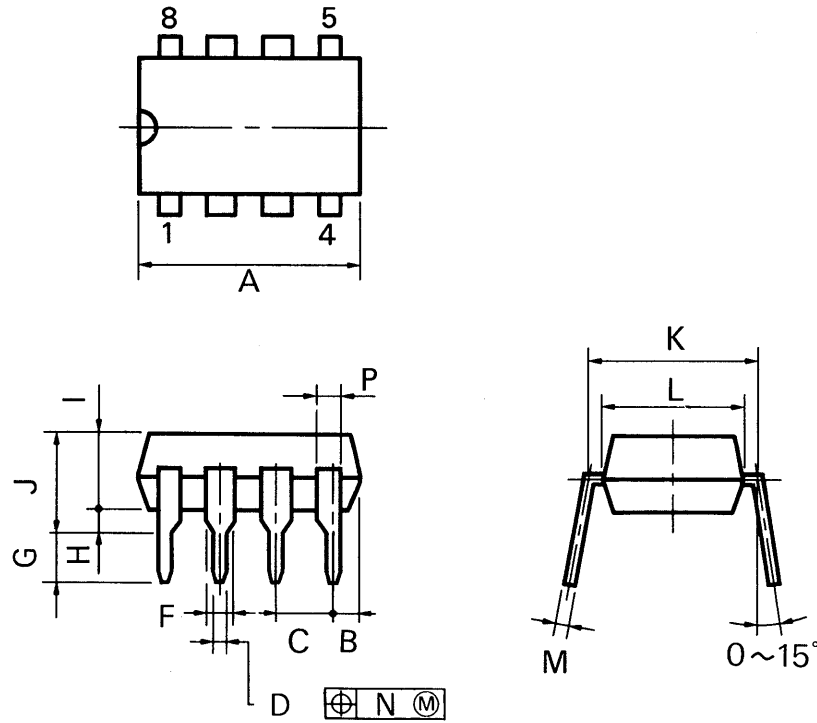

P8C-100-300B,C

NOTES

- 1) Each lead centerline is located within 0.25 mm (0.01 inch) of its true position (T.P.) at maximum material condition.
- 2) Item "K" to center of leads when formed parallel.

ITEM	MILLIMETERS	INCHES
A	10.16 MAX.	0.400 MAX.
B	1.27 MAX.	0.050 MAX.
C	2.54 (T.P.)	0.100 (T.P.)
D	0.50 ^{±0.10}	0.020 ^{+0.004} _{-0.005}
F	1.4 MIN.	0.055 MIN.
G	3.2 ^{±0.3}	0.126 ^{±0.012}
H	0.51 MIN.	0.020 MIN.
I	4.31 MAX.	0.170 MAX.
J	5.08 MAX.	0.200 MAX.
K	7.62 (T.P.)	0.300 (T.P.)
L	6.4	0.252
M	0.25 ^{+0.10} _{-0.05}	0.010 ^{+0.004} _{-0.003}
N	0.25	0.01
P	0.9 MIN.	0.035 MIN.

8PIN PLASTIC SOP (225 mil)

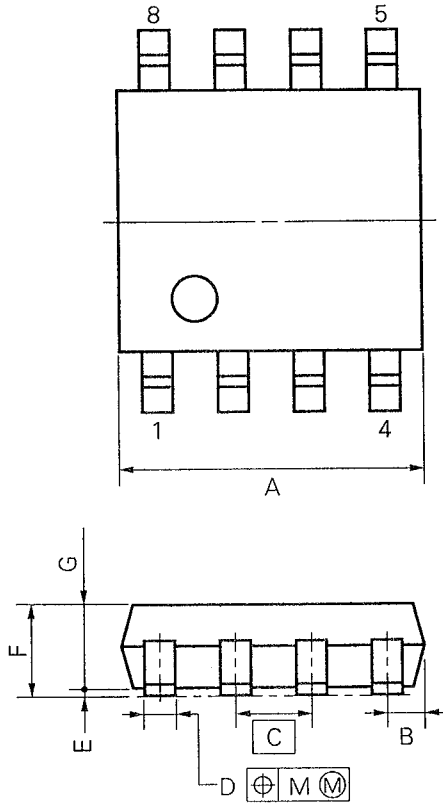

detail of lead end

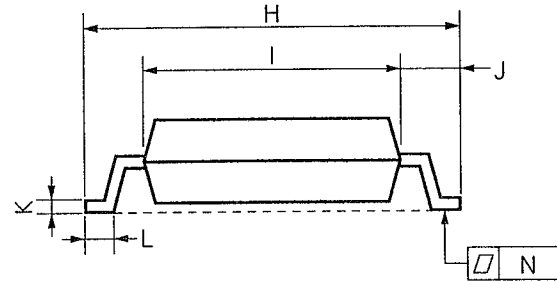
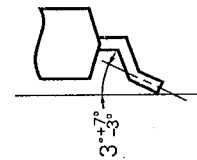

NOTE

Each lead centerline is located within 0.12 mm (0.005 inch) of its true position (T.P.) at maximum material condition.

S8GM-50-225B-2

ITEM	MILLIMETERS	INCHES
A	5.37 MAX.	0.212 MAX.
B	0.78 MAX.	0.031 MAX.
C	1.27 (T.P.)	0.050 (T.P.)
D	0.40 ^{+0.10} _{-0.05}	0.016 ^{+0.004} _{-0.003}
E	0.1±0.1	0.004±0.004
F	1.8 MAX.	0.071MAX.
G	1.49	0.059
H	6.5±0.3	0.256±0.012
I	4.4	0.173
J	1.1	0.043
K	0.15 ^{+0.10} _{-0.05}	0.006 ^{+0.004} _{-0.002}
L	0.6±0.2	0.024 ^{+0.008} _{-0.009}
M	0.12	0.005
N	0.15	0.006

RECOMMENDED SOLDERING CONDITIONS

The following conditions (see table below) must be met when soldering this product.

Please consult with our sales offices in case other soldering process is used, or in case soldering is done under different conditions.

TYPES OF SURFACE MOUNT DEVICE

For more details, refer to our document "SEMICONDUCTOR DEVICE MOUNTING TECHNOLOGY MANUAL" (IEI-1207).

[μPC4556G2]

Soldering method	Soldering conditions	Recommended condition symbol
Infrared ray reflow	Peak package's surface temperature : 230 °C or below, Reflow time : 30 seconds or below (210 °C or higher), Number of reflow process : 1, Exposure limit* : None	IR30-00-1
VPS	Peak package's surface temperature : 215 °C or below, Reflow time : 40 seconds or below (200 °C or higher), Number of reflow process : 1, Exposure limit* : None	VP15-00-1
Wave soldering	Solder temperature: 260 °C or below, Flow time: 10 seconds or below, Number of flow process: 1, Exposure limit*: None	WS15-00-1
Partial heating method	Terminal temperature : 300 °C or below, Flow time : 10 seconds or below, Exposure limit* : None	○

* Exposure limit before soldering after dry-pack package is opened.
Storage conditions: 25 °C and relative humidity at 65 % or less.

Note Do not apply more than a single process at once, except for "Partial heating method".

TYPES OF THROUGH HOLE DEVICE

[μPC4556C]

Soldering method	Soldering conditions	Recommended condition symbol
Wave soldering	Solder temperature: 260 °C or below, Flow time: 10 seconds or below	○

[MEMO]

[MEMO]

No part of this document may be copied or reproduced in any form or by any means without the prior written consent of NEC Corporation. NEC Corporation assumes no responsibility for any errors which may appear in this document.

NEC Corporation does not assume any liability for infringement of patents, copyrights or other intellectual property rights of third parties by or arising from use of a device described herein or any other liability arising from use of such device. No license, either express, implied or otherwise, is granted under any patents, copyrights or other intellectual property rights of NEC Corporation or others.

The devices listed in this document are not suitable for use in aerospace equipment, submarine cables, nuclear reactor control systems and life support systems. If customers intend to use NEC devices for above applications or they intend to use "Standard" quality grade NEC devices for applications not intended by NEC, please contact our sales people in advance.

Application examples recommended by NEC Corporation

Standard: Computer, Office equipment, Communication equipment, Test and Measurement equipment, Machine tools, Industrial robots, Audio and Visual equipment, Other consumer products, etc.

Special: Automotive and Transportation equipment, Traffic control systems, Antidisaster systems, Anticrime systems, etc.

This datasheet has been download from:

www.datasheetcatalog.com

Datasheets for electronics components.