

LINEAR INTEGRATED CIRCUITS

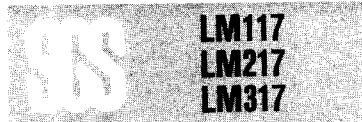

1.2V TO 37V ADJUSTABLE VOLTAGE REGULATOR

- OUTPUT VOLTAGE RANGE: 1.2 TO 37V
- OUTPUT CURRENT IN EXCESS OF 1.5A
- 0.1% LINE AND LOAD REGULATION
- FLOATING OPERATION FOR HIGH VOLTAGES
- COMPLETE SERIES OF PROTECTIONS: CURRENT LIMITING, THERMAL SHUT-DOWN AND SOA CONTROL.

They are designed to supply more than 1.5A of load current with an output voltage adjustable over a 1.2 to 37V range.

The nominal output voltage is selected by means of only a resistive divider, making the device exceptionally easy to use and eliminating the stocking of many fixed regulators.

The LM117/LM217/LM317 are monolithic integrated circuit in TO-220 and TO-3 packages intended for use as positive adjustable voltage regulators.

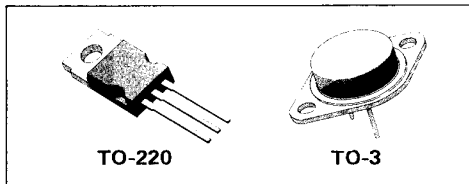

ABSOLUTE MAXIMUM RATINGS

V_{i-o}	Input-output differential voltage	40	V
I_o	Output current	Internally limited	
T_{op}	Operating junction temperature for: LM 117	-55 to 150	°C
	LM 217	-25 to 150	°C
	LM 317	0 to 125	°C
P_{tot}	Power dissipation	Internally limited	
T_{stg}	Storage temperature	-65 to 150	°C

Basic adjustable regulator

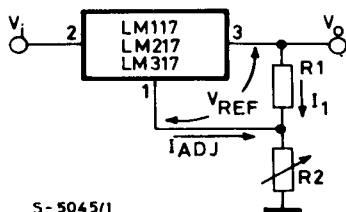

LM117
LM217
LM317

CONNECTION DIAGRAMS AND ORDERING NUMBERS

(top views)

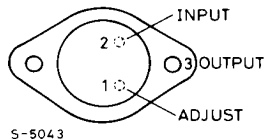
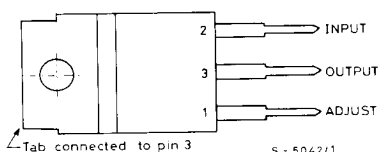

Type	TO-220	TO-3
LM 117	—	LM 117K
LM 217	—	LM 217K
LM 317	LM 317T	LM 317K

SCHEMATIC DIAGRAM

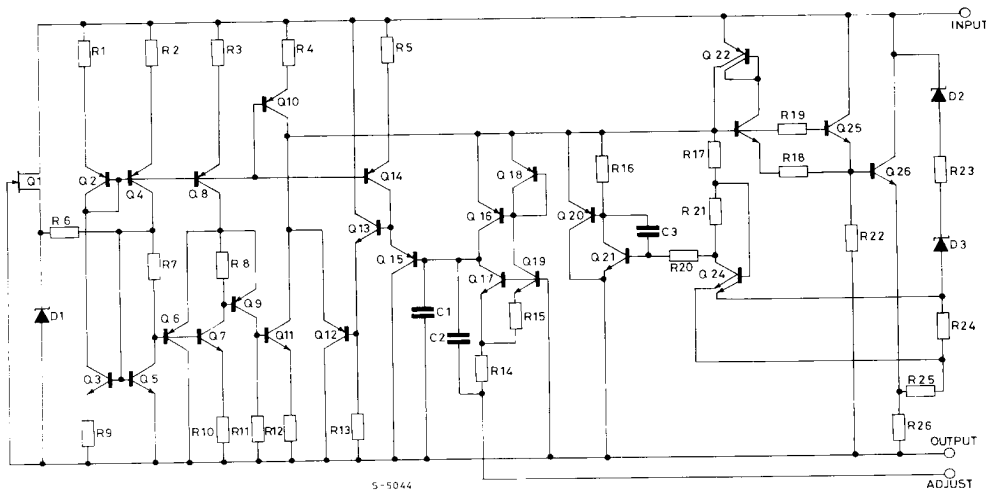

THERMAL DATA

			TO-3	TO-220
$R_{th\ j-case}$	Thermal resistance junction-case	max	4 °C/W	4 °C/W
$R_{th\ j-amb}$	Thermal resistance junction-ambient	max	35 °C/W	50 °C/W

ELECTRICAL CHARACTERISTICS ($V_i - V_o = 5V$, $I_o = 500\text{ mA}$, unless otherwise specified)

Parameter	Test conditions		LM 117/LM 217			LM 317			Unit
			Min.	Typ.	Max.	Min.	Typ.	Max.	
ΔV_o Line regulation	$V_i - V_o = 3$ to $40V$	$T_j = 25^\circ C$		0.01	0.02		0.01	0.04	%/ V
				0.02	0.05		0.02	0.07	
ΔV_o Load regulation	$V_o \leq 5V$ $I_o = 10\text{ mA}$ to $1.5A$	$T_j = 25^\circ C$		5	15		5	25	mV
				20	50		20	70	
	$V_o \geq 5V$ $I_o = 10\text{ mA}$ to $1.5A$	$T_j = 25^\circ C$		0.1	0.3		0.1	0.5	%
				0.3	1		0.3	1.5	
I_{ADJ} Adjustment pin current			50	100		50	100	μA	
ΔI_{ADJ} Adjustment pin current	$V_i - V_o = 2.5$ to $40V$ $I_o = 10\text{ mA}$ to $1.5A$			0.2	5		0.2	5	μA
V_{REF} Reference voltage (between pin 3 and pin 1)	$V_i - V_o = 3$ to $40V$ $I_o = 10\text{ mA}$ to $1.5A$		1.2	1.25	1.3	1.2	1.25	1.3	V
$\frac{\Delta V_o}{V_o}$ Output voltage temperature stability				1			1		%
$I_{o\ min}$ Minimum load current	$V_i - V_o = 40V$			3.5	5		3.5	10	mA
$I_{o\ max}$ Maximum load current	$V_i - V_o \leq 15V$		1.5	2.2		1.5	2.2		A
	$V_i - V_o = 40V$			0.4			0.4		
e_N Output noise (percentage of V_o)	$T_j = 25^\circ C$, 10Hz to 10KHz			0.003			0.003		%
SVR Supply voltage rejection (*)	$T_j = 25^\circ C$ $f = 120\text{ Hz}$	$C_{ADJ} = 0$		65			65		dB
		$C_{ADJ} = 10\ \mu F$	66	80		66	80		

(*) C_{ADJ} is connected between pin 1 and ground.

Note — Unless otherwise specified the above specs, apply over the following conditions: LM 117 $T_j = -55$ to $150^\circ C$; LM 217 $T_j = -25$ to $150^\circ C$; LM 317 $T_j = 0$ to $125^\circ C$.

LM117
LM217
LM317

Fig. 1 - Output current vs. input-output differential voltage

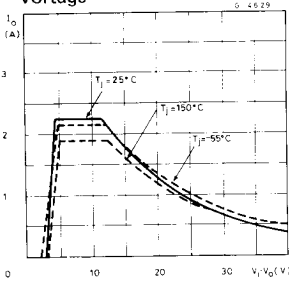

Fig. 2 - Dropout voltage vs. junction temperature

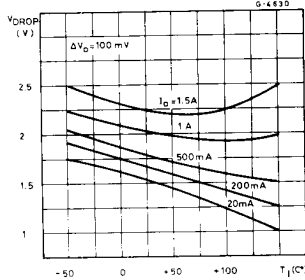
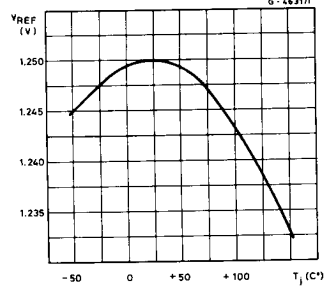

Fig. 3 - Reference voltage vs. junction temperature



APPLICATION INFORMATION

The LM 117/LM 217/LM 317 provides an internal reference voltage of 1.25V between the output and adjustment terminals. This is used to set a constant current flow across an external resistor divider (see fig. 4), giving an output voltage V_o of:

$$V_o = V_{REF} \left(1 + \frac{R_2}{R_1} \right) + I_{ADJ} R_2$$

Fig. 4 - Basic adjustable regulator

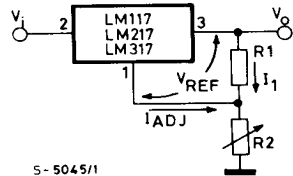

S-5045/1

The device was designed to minimize the term I_{ADJ} (100 μA max) and to maintain it very constant with line and load changes. Usually, the error term $I_{ADJ} \cdot R_2$ can be neglected. To obtain the previous requirement, all the regulator quiescent current is returned to the output terminal, imposing a minimum load current condition. If the load is insufficient, the output voltage will rise.

Since the LM 117/LM 217/LM 317 is a floating regulator and "sees" only the input-to-output differential voltage, supplies of very high voltage with respect to ground can be regulated as long as the maximum input-to-output differential is not exceeded. Furthermore, programmable regulator are easily obtainable and, by connecting a fixed resistor between the adjustment and output, the device can be used as a precision current regulator.

In order to optimise the load regulation, the current set resistor R_1 (see fig. 4) should be tied as close as possible to the regulator, while the ground terminal of R_2 should be near the ground of the load to provide remote ground sensing.

No external capacitors are required, but performance may be improved with added capacitance as follows:

- An input bypass capacitor of 0.1 μF .
- An adjustment terminal to ground 10 μF capacitor to improve the ripple rejection of about 15 dB (C_{ADJ}).
- An 1 μF tantalum capacitor on the output to improve transient response.

APPLICATION INFORMATION (continued)

In addition to external capacitors, it is good practice to add protection diodes, as shown in fig. 5.

Fig. 5 - Voltage regulator with protection diodes.

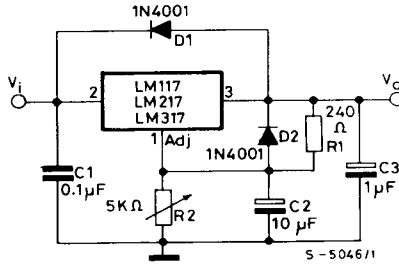

D1 protects the device against input short circuit, while D2 protects against output short circuit for capacitors discharging.

Fig. 6 - Slow turn-on 15V regulator

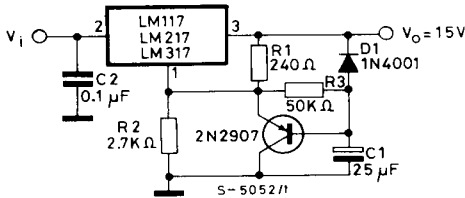

Fig. 7 - Current regulator

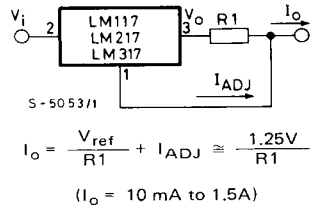

Fig. 8 - 5V electronic shut-down regulator

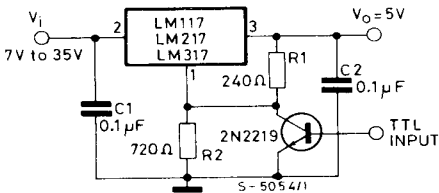
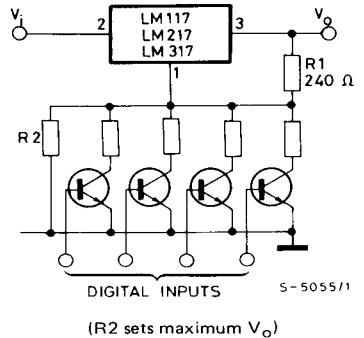
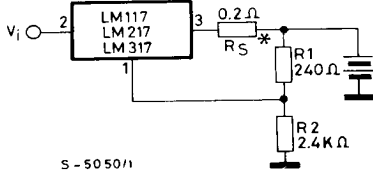

Fig. 9 - Digitally selected outputs



APPLICATION INFORMATION (continued)

Fig. 10 - Battery charger (12V).



* R_S sets output impedance of charger

$$Z_o = R_s \left(1 + \frac{R_2}{R_1} \right)$$

Use of R_S allows low charging rates with fully charged battery.

Fig. 11 - Current limited 6V charger.

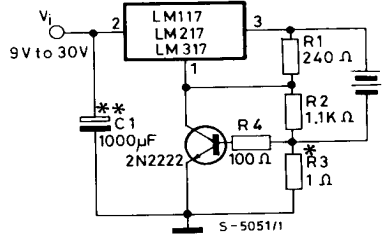

* R_3 sets peak current (0.6A for 1Ω).

** C_1 recommended to filter out input transients.

MECHANICAL DATA (Dimensions in mm)

TO-220

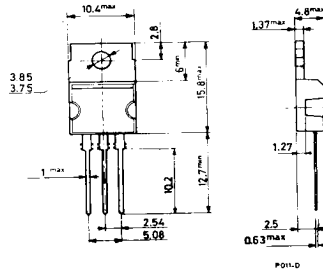

TO-3

